



Infinity S Power System

Compact, Dual Voltage, Rack Mounted Power System



Overview

The GE Infinity S DC energy system is a compact power plant that supports dual voltage (+24V/-48V) operation through the use of a comprehensive range of advanced rectifiers and DC-DC converters. Primary voltage is supported by rectifiers and battery reserve, while secondary voltage is supported by DC-DC converter modules. Primary voltage can be -48V or +24V.

The Infinity S Power System has primary voltage capacity for +24V power up to 1,200A and -48V power up to 800A. Secondary voltage capacity is up to 120A (48V out) and 300A (24V out).

Shelf / Bay Options

Infinity S systems features mounting rails for field install applications and may be equipped in a 7 ft 23" relay rack; or a half height rack for mounting on battery stands. The distribution module is 4U tall and accommodates up to 26 single voltage or selectable voltage bullet breaker positions. Universal shelves are 1U tall with four slots that accept any Infinity series rectifier or converter interchangeably in any power slot. This allows the available slots to be filled with the mix of power modules desired.

The only restriction is whether AC power is applied to the shelf. This gives extreme flexibility in the provisioning of power modules within the system.

Infinity Rectifier and Converter Family

The Infinity Series offers DC rectifiers and converters for both +24V to -48V and -48V to +24V applications. For easy module selection, the rectifiers and converters are color coded to quickly identify voltage, module type and input voltage type (AC or DC).

Galaxy Pulsar* Plus Controller

The Galaxy Pulsar Plus is used throughout many of the GE DC Power products including Infinity, CP, and SPS with the only differentiator being the form factor which is scaled to meet the nature of the application. The controller utilizes standard network management protocols allowing for advanced network supervision with SNMP communications to deliver extensive monitoring and control features with both local and remote access.

Advantages

- Dual Voltage power system with ultimate flexibility
- -48V up to 800A or +24V up to 1200A
- Secondary voltage up to 300A
- High availability wireless telecom applications
- Telecom service providers
- Efficiency approaching 97%

Infinity Rectifiers and Converters

- Compact – 1RU form factor providing high power density (24 W/in³)
- Dual Voltage compatibility – the unique connector pin designation allows the rectifier to be used in a “universal” power shelf, alongside rectifiers or DC-DC converters with different output voltages.
- Plug and Play – installation of the rectifier in a shelf connected to a compatible system controller initializes all set up parameters automatically. No adjustments are needed.
- Extended service life – parallel operation with automatic load sharing ensures that parallel units are not unduly stressed even when a unit fails or is removed.
- Monitoring / control – the built in microprocessor controls and monitors all critical rectifier functions and communicates with the system controller using the built in Galaxy Protocol serial interface.
- Fail safe performance – hot insertion capabilities allow for converter replacement without system shutdown; soft start and inrush current protection prevent nuisance tripping of upstream breakers.



Applications

- Telecommunications Networks
- Digital Subscriber Line (DSL)
- Indoor/Outdoor Wireless
- Routers/Switches
- Fiber in the Loop
- Transmission
- Data Networks
- Distributed Antenna Systems
- Off-Grid/On-Grid Renewable Energy Sites

Key Features

- Extended Temperature Range
- Redundant Fan Cooling
- Front Panel LED Indicators
- 1U Height, Hi Power Density
- 277/220/110V AC Input
- Digital Load Sharing
- Hot Pluggable
- RoHS compliant
- Direct Solar Input (no inverter required)

Specifications

INPUT	NE100AC24ATEZ NE100ECO24ATEZ	NE050AC48ATEZ NE050ECO48ATEZ	NE075AC48ATEZ	NE030DC48A	NE040DC48A	NE075DC24A
Voltage Range	95-305Vac	95-305Vac	95-305Vac	21-30Vdc	21-30Vdc	42-60Vdc
Input Current	15-12A @ 100-120Vac 15-12A @ 200-277Vac	15-12A @ 100-120Vac 15-12A @ 200-277Vac	15-12A @ 100-120Vac 22-15.5A @ 200-277Vac	63A @ 27Vdc 81A @ 21Vdc	94A @ 27Vdc 108A @ 21Vdc	41A @ 54.5Vdc 54A @ 42Vdc
Input Frequency	45 – 66Hz	45 – 66Hz	45 - 66Hz	-	-	-
Power Factor	0.98 at>50% load	0.98 at>50% load	0.98 at>50% load	-	-	-
Efficiency	> 95% (Peak 95.6%)	> 96% (Peak 96.9%)	> 96% (Peak 96.9%)	-	-	-
Total Harmonic Distortion	<5% @loads over 50%	<5% @loads over 50%	<5% @loads over 50%	-	-	-

Specifications (Cont.)

OUTPUT	NE100AC24ATEZ NE100ECO24ATEZ	NE050AC48ATEZ NE050ECO48ATEZ	NE075AC48ATEZ	NE030DC48A	NE040DC48A	NE075DC24A
Voltage Adjust Range	21-29Vdc	42-58Vdc	42-58Vdc	46-57Vdc	46-57Vdc	23-28Vdc
Voltage Nominal	27.25V	54.5V	54.5V	52.0V	52.0V	27.2V
Regulation (with controller)	±0.5%	±0.5%	±0.5%	±0.5%	±0.5%	±0.5%
Ripple	100mVrms	100mVrms	100mVrms	100mVrms	100mVrms	100mVrms
Output Current - High-Line	114A @24V 100A @27.25V	57A @48V 50A @54.5V	82A@48V 75A @54.5V	30A @52.0V -	40A @52.0V -	75A @27.2V -
- Low-Line	44A @27.25V	22A @54.5V	22A @54.5V	-	-	-
Heat Dissipation @ max out ¹	174W / 594 BTU/hr	158W / 539 BTU/hr	249W / 850 BTU/hr	154W / 525 BTU/hr	205W / 700 BTU/hr	202W / 689 BTU/hr

¹ Special room cooling may be required.

ENVIRONMENTAL

Operating Temperature	-40°C to +75°C (-40°F to 167°F) Full capacity up to 55°C; output derates 2%/°C from 55°C to 75°C
Storage Temperature	-40°C to +85°C (-40°F to 185°F)
Humidity	< 95% non-condensing
Altitude	4000M (for altitudes above 2000M, peak operating temperature de-rates 0.656° C /100M; 4000M peak temperature rating is 62°C

MECHANICAL

Length (inch/mm)	13.85 / 351.8
Width (inch/mm)	5.23 / 133
Height (inch/mm)	1.63 / 42
Weight (lb/Kg)	5.05 / 2.2

SAFETY AND STANDARDS COMPLIANCE

NEBs Level 3	Evaluated by independent NRTL test lab to Telcordia GR63-CORE and GR1089-CORE Issue 6 [Level 3]
Safety	ANSI/UL60950-1-2014 and CAN/CSA C22.2 No. 60950-1-07, Second Edition + A2:2014 (MOD), dated October 14, 2014
RoHS	Compliant to RoHS EU Directive 2002/95/EC; RoHS 6/6 models with Z suffix (RoHS 5/6 all other models)
EMC	European Directive 2014/30/EU; EN55032, Class A; EN55035; FCC, Class A; GR1089-CORE
ESD	EN61000-4-2, Level 4

OUTLINE DRAWING

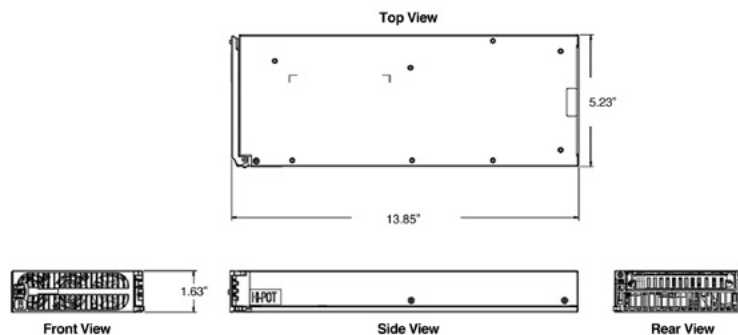

Pulsar Plus Controller

The Pulsar Plus family of controllers provides system monitoring and control features for Infinity, CP, and other power systems. These controllers monitor and control system components including rectifiers, converters, and distribution modules via a multi-drop RS485 digital communications bus. System status, parameters, settings, and alarm thresholds can be viewed and configured from the controller's front panel display. Assignment and configuration of alarm inputs and output relays can be performed from a laptop computer connected to a local RS-232 or Ethernet port, or by remote access is through a secure network connection to the World Wide Web (internet) or your enterprise network (intranet). An optional modem is also available.



This controller utilizes standard network management protocols allowing for advanced network supervision. The GE Galaxy Manager* software is the centralized visibility and control component of a comprehensive power management system designed to meet engineering, operations and maintenance needs. The Galaxy Manager client-server architecture enables remote access to system controllers across the power network, featuring ECO Priority advanced monitoring features which provides detailed energy source analysis to help better customize your renewable energy resources.

Applications

- Telecommunications Networks
- Digital Subscriber Line (DSL)
- Indoor/Outdoor Wireless
- Routers/Switches
- Fiber in the Loop
- Transmission
- Off-Grid/On-Grid Renewable Energy Sites
- Data Networks
- PBX

Key Features

Remote Access and Features

- Integrated 10/100Base-T Ethernet Network
 - TCP/IP with IPV6 Capability
 - SNMP V3 for management
 - SMTP for email
 - Telnet for command line interface
 - DHCP for plug-n-play
 - FTPS for rapid backup and upgrades
 - HTTPS for standard web pages and browsers
 - Compatible with Galaxy Manager and other management packages
 - Shielded RJ-45 interface referenced to chassis ground
- Password protected security levels: User, Super-User, Administrator for all access
- Ground-referenced RS232 system port
- ANSI T1.317 command-line interface
- Modem access support
 - Remote via external modem
 - Callback security
- EasyView2, Windows-based GUI software for local terminal or Modem access

- ECO Priority controls and features
 - Advanced generator controls to help minimize fuel consumption for off grid applications
 - ECO Energy Management allowing for non-ECO sources outputs to be minimized while ECO resources are available
 - Source and load trend logging

Standard System Features

- Monitor and control of more than 40 connected devices
 - Robust RS485 system bus
- Standard and user defined alarms
 - Alarm test
 - Assignable alarm severity: Critical, Major, Minor, Warning, and record-only
 - 10 alarm relays (7 user assigned)
- Rectifier management features
 - Automatic rectifier restart
 - Active Rectifier Management ARM (energy efficiency)
 - Remote rectifier (on/off)
 - Reserve Operation
 - Automatic rectifier sequence control
 - N + X redundancy check

- Multiple Low Voltage Load and Low Voltage Battery Disconnect thresholds
- Configuration, statistics, and history
 - All stored in non-volatile memory
 - Remote/local backup and restore of configuration data
- Industry standard defaults
 - Customer specific configurations available
- Remote/local software upgrade
- Basic, busy hour, and trend statistics
- Detailed event history
- User defined events and derived channels

Standard Battery Management Features

- Float/boost mode control
 - Manual boost
 - Manual timed boost locally, T1.317, and remotely initiated
 - Auto boost terminated by time or current
- Battery discharge testing
 - Manual (local/remote)
 - Periodic
 - Plant Battery Test (PBT) input driven

Key Features (Cont.)

- Configurable threshold or 20% algorithm
- Graphical discharge data
- Rectifiers on-line during test
- Slope thermal compensation
 - High temperature
 - Low temperature
 - Step temperature
 - STC Enable/Disable, low temperature Enable/Disable
 - Configurable mV/°C slopes
- State of charge indication
- High temperature disconnect setting
- Reserve-time prediction
- Recharge current limit
- Emergency Power-Off input

Integrated Monitoring Inputs/Outputs

- System plant voltage (accuracy ±0.5%, resolution 0.01V)
- One system shunt (accuracy ±0.5% full scale, resolution 1A)
 - Battery or load
 - Mounted in the return side of DC bus
- Up to 15 binary inputs
 - 6 inputs close/open to battery
 - 9 input close/open to return
 - User assignable
- Up to 7 Form-C output alarms (60VDC @ .5A)
 - User assignable
- 1-Wire™ bus devices
 - Up to 16 temperature probes (QS873)
 - Up to 6 mid-string monitors (ES771)

Galaxy Manager Compatible

- Centralized web server and database with multiple user access to live or managed data with drill down to problem details
- Monitor and control of more than 40 connected devices
- Management information from polling or alarms received from alarm traps from multiple sites are available on one screen via the inter/intranet
- Trend user selected data over time
- Automatic or manual report generation
- Standard engineering tools like reserve time calculators and cable voltage drop analyzer

Specifications

GENERAL	
Operating Voltage	±24 Vdc, ±48 Vdc (Range: ±18 to ±60 Vdc)
Input Power	Less than 7W
Operating Temperature Range	-40°C to +75°C (-40°F to 167°F)
Operating Relative Humidity	0 - 95% (non-condensing)
Storage Temperature Range	-40°C to +85°C (-40°F to 185°F)
Physical Specifications	Sizes vary by packaging option
Display	8-line by 40-character with alarm context sensitive backlit LCD

The diagram illustrates the LCD display's color-coded states for different battery conditions. Each state shows a voltage of -54.48V and a current of 100A. The states are: Green (No Alarms, Menu), Amber (Float, Menu), Yellow (CHARGE, Menu), and Red (CHARGE, Menu).

SAFETY AND STANDARDS COMPLIANCE	
NEBs	Evaluated by independent NRTL test lab to Telcordia GR63, Issue 3 and GR1089-CORE, Issue 6
Safety	ANSI/UL60950-1-2014 and CAN/CSA C22.2 No. 60950-1-07, Second Edition + A2:2014 (MOD), dated October 14, 2014
RoHS	Compliant to RoHS EU Directive 2002/95/EC RoHS 6/6
EMC	European Directive 2014/30/EU; EN55032, Class A, EN55035; FCC, Class A; GR1089-CORE, Issue 6

AGENCY CERTIFICATIONS	
NEBs Level 3	Evaluated by independent NRTL test lab to Telcordia GR63, Issue 3 and GR1089-CORE, Issue 6
EMC	European Directive 2014/30/EU; EN55032, (CISPR22) Class A, EN55035 (CISPR24)
Safety	Underwriters Laboratories (UL) Listed per Subject Letter 1801: Power Distribution Center for (CSA 22.2 950): Safety of Information Technology Equipment

Pulsar Edge Controller

The SPS Pulsar Edge controller delivers large system intelligence in a small system form factor. This family of controllers functions as network interface cards (NIC) and as a full-featured battery plant controller. Its thin modular plug-in form factor minimizes shelf space consumption allowing maximum power module and distribution capabilities.



The controller is utilized in bulk power applications in data centers and enterprise applications. Ethernet connectivity with SNMP V3 facilitates secure remote network management. Access through its front-accessible RS232 or USB port and aided by the EasyView2 graphical interface enables full user interface locally. Optional 1U display version allows convenient access to all controller functions without requiring external cable connections. The display also features alarm context sensitive backlighting for at-a-glance system status.

As a battery plant controller, it provides a complete set of features to monitor and control rectifiers, batteries, and distribution. A flexible set of configurable inputs allow the Pulsar Edge controller to monitor a wide variety of system equipment and incorporate appropriate state information enabling a centralized point of management. The controller utilizes standard network management protocols allowing for advanced network supervision. GE Galaxy Manager* software is the centralized visibility and control component of a comprehensive power management system designed to meet engineering, operations and maintenance needs. The Galaxy Manager client-server architecture enables remote access to system controllers across the power network.

Applications

- Telecommunications Networks
- Digital Subscriber Line (DSL)
- Indoor/Outdoor Wireless
- Routers/Switches
- Fiber in the Loop
- Transmission
- Data Networks
- PBX

Key Features

Remote Access and Features

- Integrated 10/100Base-T Ethernet Network
 - TCP/IP with IPV6 Support
 - SNMP V3 for management
 - SMTP for email
 - Telnet for command line interface
 - DHCP for plug-n-play
 - FTPS for rapid backup and upgrades
 - HTTPS for standard web pages and browsers
 - Compatible with Galaxy Manager and other management packages
 - Shielded RJ-45 interface referenced to chassis ground
- Password protected security levels: User, Super-User, Administrator for all access
- Ground-referenced RS232 system port
- ANSIT1.317 command-line interface
- Modem access support
 - Remote via external modem
 - Callback security

- EasyView2, Windows-based GUI software for local terminal or Modem access
- Optional 1U display with alarm indicating backlight feature

Standard System Features

- Monitor and control of more than 40 connected devices
 - Maximum of 32 rectifiers
 - Maximum of 6 distribution control cards
 - Robust RS485 system bus
- Standard and user defined alarms
 - Alarm test
 - Assignable alarm severity: Critical, Major, Minor, Warning, and record-only
- Rectifier management features
 - Automatic rectifier restart
 - Adaptive Rectifier Management (energy efficiency)
 - Remote rectifier (on/off)
 - Reserve Operation

- Automatic rectifier sequence control
- N + X redundancy check
- Multiple Low Voltage Load and Low Voltage Battery Disconnect thresholds (4)
- Configuration, statistics, and history
 - All stored in non-volatile memory
 - Remote/local backup and restore of configuration data
- Industry standard defaults
 - Customer specific configurations available
- Remote/ local software upgrade
- Basic, busy hour, and trend statistics
- Detailed event history
- User defined events and derived channels

Key Features (Cont.)

Standard Battery Management Features

- Float/boost mode control
 - Manual boost
 - Manual timed boost locally, T1.317, and remotely initiated
 - Auto boost terminated by time or current
- Battery discharge testing
 - Manual (local/remote)

- Periodic
- Plant Battery Test (PBT) input driven
- Configurable threshold or 20% algorithm
- Graphical discharge data
- Rectifiers on-line during test
- Slope thermal compensation
 - High temperature
 - Low temperature
 - Step temperature

- STC Enable/Disable, low temperature Enable/Disable
- Configurable mV/°C slopes
- State of charge indication
- High temperature disconnect setting
- Reserve-time prediction
- Recharge current limit
- Emergency Power-Off input

Integrated Monitoring Inputs/Outputs

- System plant voltage (accuracy $\pm 0.5\%$, resolution 0.01V)
- One system shunt (accuracy $\pm 1\%$ full scale, resolution 1A)
 - Battery or load
 - Mounted in the return side of DC bus
- Up to 15 binary inputs
 - 6 inputs close/open to battery
 - 9 input close/open to return (number is dependent upon number of output alarms)
 - User assignable
- Up to 6 user assignable Form-C output alarms (50VDC @.3A)
- 1-Wire™ bus devices
 - Up to 16 temperature probes (QS873)
 - Up to 6 mid-string monitors (ES771)

Galaxy Manager Compatible

- Centralized web server and database with multiple user access to live or managed data with drill down to problem details
- Monitor and control of more than 40 connected devices
- Management information from polling or alarms received from alarm traps from multiple sites are available on one screen via the inter/intranet
- Trend user selected data over time
- Automatic or manual report generation
- Standard engineering tools like reserve time calculators and cable voltage drop analyzer

Specifications

GENERAL	
Operating Voltage	± 24 Vdc, ± 48 Vdc (Range: ± 18 to ± 60 Vdc)
Input Power	Less than 7W
Operating Temperature Range	-40°C to +70°C (-40°F to 167°F)
Operating Relative Humidity	0 - 95% (non-condensing)
Storage Temperature Range	-40°C to +85°C (-40°F to 185°F)
Physical Specifications	1.75 in. H, 0.75 in. W, 8.00 in. D; 0.5lb
Display	8-line by 40-character backlit LCD
EMC	FCC/EN55032 Class A, CISPR22 Level A

AGENCY CERTIFICATIONS	
Electrostatic Discharge	EN 61000-4-2 level 4
Radiated Emissions	FCC, Class A; EN 55032, Class A
Safety	UL listed Component as Part of CPL or SPS Power System; ANSI/UL60950-1-2014 and CAN/CSA C22.2 No. 60950-1-07, Second Edition + A2:2014 (MOD), dated October 14, 2014

Infinity S System

Infinity S may be configured as a +24V or -48V single voltage power system or as a dual voltage power system that supports rectifiers and converters. The primary voltage is supported by +24V or -48V rectifiers and battery reserve, while secondary voltage is supported by DC-DC converters. Infinity-S includes dedicated 24V, 48V and return buses. The primary voltage capacity is 1,200A at 24V and 800A at 48V. Secondary (-48V) voltage capacity is up to 120A, (24V) voltage capacity is up to 300A. The system includes low voltage battery disconnect option for the primary voltage. A low voltage load disconnect option can be used for load shedding to maintain critical loads.



Applications

- Wireless Telecom Networks
- Indoor/Outdoor Wireless
- Transmission
- Data Networks
- Off-Grid/On-Grid Renewable Energy Sites

Key Features

- Dual Voltage Flexibility
- Redundant Fan Cooling
- Front Panel LED Indicators
- 1U Height, Hi Power Density
- 220/110 V AC Input
- Digital Load Sharing
- Hot Pluggable
- RoHS Compliant
- ECO Priority Ready

Specifications

INPUT	MIN	TYP	MAX
Voltage Range			
- High-Line	175Vac	220Vac	305Vac
- Low-Line	85Vac	110Vac	140Vac
Frequency	45Hz	60Hz	66Hz
Power Factor	98%	99.5%	
Total Harmonic Distortion			5%

PRIMARY OUTPUT		
Nominal Voltage	24Vdc	-48Vdc
Output Current	1,200A	800A
Vo Setpoint (factory)	27.2Vdc±1%	-54.5Vdc±1%
Vo Range	+21Vdc to +29Vdc	-42Vdc to -58Vdc
Regulation	±0.5%	

SECONDARY OUTPUT		
Nominal Voltage	-48Vdc	+24Vdc
Output Current	120A	300A
Vo Setpoint (factory)	-54.5Vdc±1%	27.25Vdc±1%
Vo Range	-42Vdc to -58Vdc	+21Vdc to +29Vdc
Regulation	±0.5%	

Specifications (Cont.)

MECHANICAL	SYSTEM ONLY	FRAME MOUNTED SYSTEM
Height (in. /mm)	21.25 / 540 (Base system with 4 power shelves and 2 distributions)	84 / 2134
Width (in. /mm)	19 / 482.6 or 23 / 584.2	23 / 584.2 or 26 / 660.4
Depth (in. /mm)	21 / 533	21 / 533
Weight (lb / Kg)	108 / 49 (Base system with 4 power shelves and 2 distributions) 292 / 132.5 (Base system in 23" Frame with 4 power shelves and 2 distributions)	292 / 132

ENVIRONMENTAL	
Operating Temperature	-40°C to +75°C (-40°F to 167 °F)
Storage Temperature	-40°C to +85°C (-40°F to 185 °F)
Relative Humidity	95% max, non-condensing
Altitude	4000M (for altitudes above 2000M, peak operating temperature de-rates 0.656° C /100M; 4000M peak temperature rating is 62° C)

SAFETY AND STANDARDS COMPLIANCE	
NEBs	Evaluated by independent NRTL test lab to Telcordia GR63-CORE and GR1089-CORE [Level 3] ISSUE 6
Safety	ANSI/UL60950-1-2014 and CAN/CSA C22.2 No. 60950-1-07, Second Edition + A2:2014 (MOD), dated October 14, 2014
RoHS	Compliant to RoHS EU Directive 2002/95/EC RoHS 6/6
EMC	European Directive 2014/30/EU; EN55032, Class A; EN55035; FCC, Class A; GR1089-CORE ISSUE 6

AGENCY CERTIFICATIONS	
CSA	ANSI/UL60950-1-2014 and CAN/CSA C22.2 No. 60950-1-07, Second Edition + A2:2014 (MOD), dated October 14, 2014
EMI/EMC	European Directive 2014/30/EU; EN55032 (CISPR22) Class A; EN55035 (CISPR24)
NEBS LEVEL 3	GR1089-CORE Special equipment room cooling may be needed - heat dissipation exceeds values of GR-63 Table 4-5

OUTLINE DRAWING (FOR VISUAL REFERENCE ONLY)

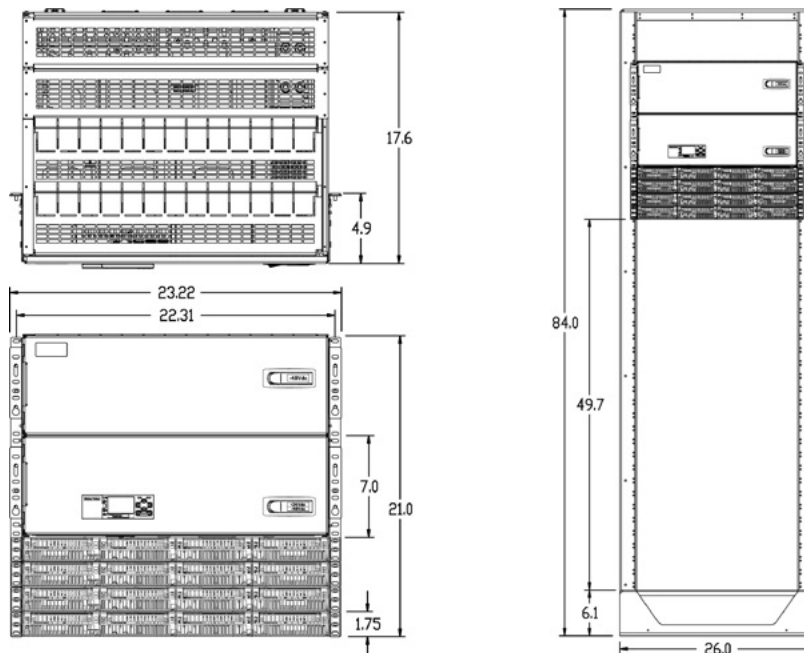

Shelf Specifications

MECHANICAL	
Height	4RU main cabinet plus 1RU per power shelf – Base system 5RU (8.75 inches / 222mm)
Width (with mounting ears)	23 inches (584mm)
Depth	18 inches (457mm), 21 inches (533mm) for systems equipped with AC5 input
Weight (without rectifiers)	Approximately 42lbs (19kg) – Base system with 1 rectifier shelf

ENVIRONMENTAL	
NEBs	Evaluated by independent NRTL test lab to Telcordia GR63-CORE and GR1089-CORE ISSUE 6 [Level 3]
Safety	ANSI/UL60950-1-2014 and CAN/CSA C22.2 No. 60950-1-07, Second Edition + A2:2014 (MOD), dated October 14, 2014
RoHS	Compliant to RoHS EU Directive 2002/95/EC RoHS 6/6
EMC	European Directive 2014/30/EU; EN55032, Class A; EN55035; FCC, Class A; GR1089-CORE ISSUE 6

AGENCY CERTIFICATIONS	
UL	ISSUE 6
EMI/EMC	European Directive 2014/30/EU; EN55032 (CISPR22) Class A; EN55035 (CISPR24)
NEBS LEVEL 3	GR1089-CORE ISSUE 6

Additional Information

Product Documentation

CC848815341	Advanced Features User Guide for the Pulsar Plus Controller, 167-792-183
CC848908475	Infinity S Quick Start Guide
850022389	Infinity S Quick Start Guide, Dual Voltage Systems
CC848836981	User Guide for the Galaxy Pulsar Edge Family of System Controllers

Ordering Information – Infinity S Power System

Ordering Guide

Infinity S may be configured as a +24V or -48V single voltage power system or as a “dual voltage” power system that supports rectifiers and converters. The primary voltage is supported by +24V or -48V rectifiers and battery reserve, while secondary voltage is supported by DC-DC converters. The primary voltage capacity is 1,200A at 24V and 800A at 48V. Secondary voltage capacity is up to 120A (-48V), 300A (24V).







Infinity S systems may be equipped in a 7ft framework, a half height (42”) frame for mounting on battery stands, integrated into cabinet applications, or supplied frameless for field install applications.

Features

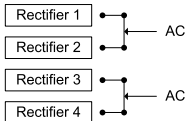
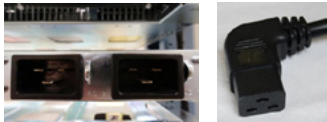
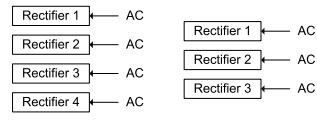
- Infinity Series Rectifiers for +24V and -48V applications.
- Dual Voltage Bus architecture for easy growth and voltage migration
- DC-DC Converter support for dual voltage systems
- DC Distribution for both voltages, with Selectable Voltage panel availability
- Temperature hardened harsh environments. (-40°C to +75°C)
- Compact size: Base System with 1 power shelf occupies 5 RU (8.75 in) of 19” or 23” rack space (18”-21” depth)
- Frame options – Factory installed in 7ft or 42” tall, 19” or 23” wide frame or field installed in user supplied frame
- Battery connections, LVBD and LVLD options.
- Plug-N-Play Pulsar Plus controller with Web based interface for local and remote (LAN) access.
- Distribution options include 3A-250A bullet style circuit breakers, and GMT fuses

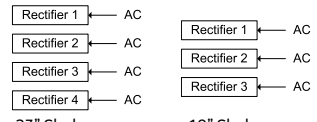
AC Input Types

TYPE	DESCRIPTION	SCHEMATIC
AC1	Dual Feed, Molex Mini-fit Sr  23” Shelves	
AC3	Individual Feed, IEC-320 C19 Receptacles  23” Shelves	 23” Shelves 19” Shelves
AC5	Individual Feed, Terminal Strip, 3/4” Conduit or Cord Grip  23” Shelves	 23” Shelves 19” Shelves
AC6	Three Phase, terminal strip input Rear cover is equipped with a 1” conduit knockout	 19” Shelves

DC Output Types

-48V SINGLE VOLTAGE SYSTEMS

Type	Description	Schematic
DC1E	<p>Single External Bullet Breaker Distribution Panel</p> <p>20 Positions for 19" configuration / 26 Positions for 23" configuration</p> <p>Ratings: 400A output (400A discharge) for 19", 600A output (600A discharge) for 23", 250A max breaker (65°C Ambient)</p>	<p>A+B = 26 Positions total for 23" System; Each position configurable for Battery or Load</p>

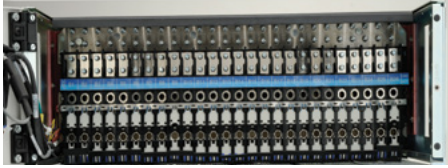

DC2E	<p>Dual External Bullet Breaker Distribution Panel</p> <p>40 Positions for 19" configuration / 52 Positions for 23" configuration</p> <p>Ratings: 600A output (600A discharge) for 19", 600A output (600A discharge) for 23", 250A max breaker (65°C Ambient)</p>	<p>A+B = 52 Positions total for 23" System; Each position configurable for Battery or Load, Second distribution panel 26 Positions dedicated to Load Breakers only</p>
------	---	--



DUAL VOLTAGE SYSTEMS

Type	Description	Schematic
DC1E	<p>Single External Dual Voltage Bullet Breaker Distribution Panel</p> <p>26 Positions for 23" configuration</p> <p>Ratings: 800A primary voltage output (800A discharge) and up to 300A secondary voltage output, 250A max breaker (65°C Ambient)</p>	<p>A+B = 26 Positions total for 23" System; Each position configurable for Primary or Secondary Loads; Dedicated Battery Bus</p>



DC2E	<p>Dual External Dual Voltage Bullet Breaker Distribution Panel</p> <p>52 Positions for 23" configuration</p> <p>Ratings: 800A primary voltage output (800A discharge) and up to 300A secondary voltage output, 250A max breaker (65°C Ambient)</p>	<p>A+B = 52 Positions total for 23" System; 26 positions configurable for Primary or Secondary Loads with 26 positions for Primary Loads only; Dedicated Battery Bus</p>
------	---	--



Step 1: Select the Base Power System

Single Voltage System -48V, 19" Width

OUTPUT RATING	DESCRIPTION	AC INPUT	LVD	FRAME	ORDERING CODE	MODEL	PHOTO
-48V 225A	225A Infinity S Power system equipped with 3 universal positions and 20 distribution positions selectable between -48V Load and Battery System - 5RU	Ind. Term Block	No		150033064	NES48-19-AC5-PS3-DC1E	
		3 Phase Term Block	No		150033083	NES48-19-AC6-PS3-DC1E	
		Ind. Term Block	LVBD		150032370	NES48-19-AC5-PS3-DC1E-LVBD	
		3 Phase Term Block	LVBD		150033093	NES48-19-AC6-PS3-DC1E-LVBD	
-48V 450A	450A Infinity S Power system equipped with 6 universal positions and 20 distribution positions selectable between -48V Load and Battery System - 6RU	Ind. Term Block	No		150033065	NES48-19-AC5-PS6-DC1E	
		3 Phase Term Block	No		150033084	NES48-19-AC6-PS6-DC1E	
		Ind. Term Block	LVBD		150033073	NES48-19-AC5-PS6-DC1E-LVBD	
		3 Phase Term Block	LVBD		150033094	NES48-19-AC6-PS6-DC1E-LVBD	
-48V 450A	450A Infinity S Power system equipped with 6 universal positions and 40 total distribution positions, 20 of which are selectable between -48V Load and Battery System - 10RU	Ind. Term Block	No		150033070	NES48-19-AC5-PS6-DC2E	
		3 Phase Term Block	No		150033087	NES48-19-AC6-PS6-DC2E	
		Ind. Term Block	LVBD		150033078	NES48-19-AC5-PS6-DC2E-LVBD	
		3 Phase Term Block	LVBD		150033097	NES48-19-AC6-PS6-DC2E-LVBD	
-48V 450A	450A Infinity S Power system equipped with 9 universal positions and 20 distribution positions selectable between -48V Load and Battery System - 7RU	Ind. Term Block	No		150033066	NES48-19-AC5-PS9-DC1E	
		3 Phase Term Block	No		150033085	NES48-19-AC6-PS9-DC1E	
		Ind. Term Block	LVBD		150033074	NES48-19-AC5-PS9-DC1E-LVBD	
		3 Phase Term Block	LVBD		150033095	NES48-19-AC6-PS9-DC1E-LVBD	
-48V 600A	600A Infinity S Power system equipped with 9 universal positions and 40 total distribution positions, 20 of which are selectable between -48V Load and Battery System - 11RU	Ind. Term Block	No		150033071	NES48-19-AC5-PS9-DC2E	
		3 Phase Term Block	No		150033088	NES48-19-AC6-PS9-DC2E	
		Ind. Term Block	LVBD		150033079	NES48-19-AC5-PS9-DC2E-LVBD	
		3 Phase Term Block	LVBD		150033098	NES48-19-AC6-PS9-DC2E-LVBD	





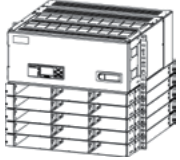
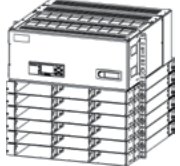

Step 1: Select the Base Power System (Cont.)

Single Voltage System -48V, 19" Width

OUTPUT RATING	DESCRIPTION	AC INPUT	LVD	FRAME	ORDERING CODE	MODEL	PHOTO
-48V 450A	450A Infinity S Power system equipped with 12 universal positions and 20 distribution positions selectable between -48V Load and Battery System - 8RU	Ind. Term Block	No		150033067	NES48-19-AC5-PS12-DC1E	
		3 Phase Term Block	No		150033086	NES48-19-AC6-PS12-DC1E	
		Ind. Term Block	LVBD		150033075	NES48-19-AC5-PS12-DC1E-LVBD	
		3 Phase Term Block	LVBD		150033096	NES48-19-AC6-PS12-DC1E-LVBD	
-48V 600A	600A Infinity S Power system equipped with 12 universal positions and 40 total distribution positions, 20 of which are selectable between -48V Load and Battery System - 12RU	Ind. Term Block	No		150033072	NES48-19-AC5-PS12-DC2E	
		3 Phase Term Block	No		150033089	NES48-19-AC6-PS12-DC2E	
		Ind. Term Block	LVBD		150033080	NES48-19-AC5-PS12-DC2E-LVBD	
		3 Phase Term Block	LVBD		150033099	NES48-19-AC6-PS12-DC2E-LVBD	
-48V 450A	450A Infinity S Power system equipped with 15 universal positions and 20 distribution positions selectable between -48V Load and Battery Additional rectifier positions intended for Eco Priority solutions System - 9RU	Ind. Term Block	No		150033068	NES48-19-AC5-PS15-DC1E	
		Ind. Term Block	LVBD		150033076	NES48-19-AC5-PS15-DC1E-LVBD	
-48V 450A	450A Infinity S Power system equipped with 18 universal positions and 20 distribution positions selectable between -48V Load and Battery Additional rectifier positions intended for Eco Priority solutions System - 10RU	Ind. Term Block	No		150033069	NES48-19-AC5-PS18-DC1E	
		Ind. Term Block	LVBD		150033077	NES48-19-AC5-PS18-DC1E-LVBD	

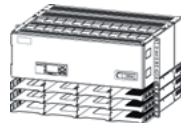

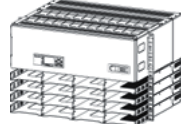



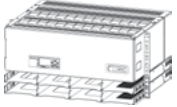

Step 1: Select the Base Power System (Cont.)

Single Voltage System -48V, 23" Width

OUTPUT RATING	DESCRIPTION	AC INPUT	LVD	FRAME	ORDERING CODE	MODEL	PHOTO
-48V 200A	200A Infinity S Power system equipped with 4 rectifier positions and 26 distribution positions which are selectable between -48V Load and Battery System - 5RU	Dual Molex	No		CC109163696	NES48 -23 -AC1 -PS4 -DC1E	
		Dual Molex	LVBD		CC109160438	NES48 -23 -AC1 -PS4 -DC1E -LVBD	
-48V 300A	300A Infinity S Power system equipped with 4 rectifier positions and 26 distribution positions which are selectable between -48V Load and Battery. System - 5RU	Ind. Term Input	No		150045731	NES48-23-AC5H-PS4-DC1E	
		Ind. Term Input	LVBD		150045737	NES48-23-AC5H-PS4-DC1E-LVBD	
-48V 400A	400A Infinity S Power system equipped with 8 rectifier positions and 26 distribution positions selectable between -48V Load and Battery System - 6RU	Dual Molex	No		CC109163705	NES48 -23 -AC1 -PS8 -DC1E	
		Dual Molex	LVBD		CC109165998	NES48 -23 -AC1 -PS8 -DC1E -LVBD	
-48V 600A	600A Infinity S Power system equipped with 12 rectifier positions and 26 distribution positions selectable between -48V Load and Battery System - 7RU	Dual Molex	No		CC109163713	NES48 -23 -AC1 -PS12 -DC1E	
		Ind. Term Block	No		150045733	NES48 -23 -AC5H -PS12 -DC1E	
		Ind. Term Block	No		150045732	NES48-23-AC5H-PS8-DC1E	
		Dual Molex	LVBD		CC109167920	NES48 -23 -AC1 -PS12 -DC1E -LVBD	
		Ind. Term Block	LVBD		150045739	NES48 -23 -AC5H -PS12 -DC1E -LVBD	
		Ind. Term Block	LVBD		150045738	NES48-23-AC5H-PS8-DC1E-LVBD	
-48V 600A	600A Infinity S Power system equipped with 12 rectifier positions and 52 total distribution positions, 26 of which are selectable between -48V Load and Battery System - 11RU	Dual Molex	No		CC109171286	NES48 -23 -AC1 -PS12 -DC2E	
		Dual Molex	LVBD		CC109171278	NES48 -23 -AC1 -PS12 -DC2E -LVBD	
-48V 600A	600A Infinity S Power system equipped with 16 rectifier positions and 26 distribution positions selectable between -48V Load and Battery System - 8RU	Ind. Term Block	No		150045735	NES48 -23 -AC5H -PS16 -DC1E	
		Ind. Term Block	LVBD		150045742	NES48 -23 -AC5H -PS16 -DC1E -LVBD	
-48V 800A	800A Infinity S Power system equipped with 16 rectifier positions and 52 total distribution positions, 26 of which are selectable between -48V Load and Battery System - 12RU	Ind. Term Block	No		150045734	NES48-23-AC5H-PS12-DC2E	
		Ind. Term Block	LVBD		150045740	NES48-23-AC5H-PS12-DC2E-LVBD	
		Ind. Term Block	No		150045736	NES48 -23 -AC5H -PS16 -DC2E	
		Ind. Term Block	LVBD		150045741	NES48-23-AC5H-PS12-DC2E-LVLD	
		Ind. Term Block	LVBD		150045743	NES48 -23 -AC5H -PS16 -DC2E -LVBD	

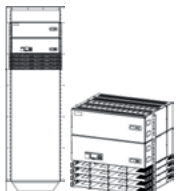

Step 1: Select the Base Power System (Cont.)

Dual Voltage Infinity S Power Systems, -48V Primary with +24V Secondary 23" Width









OUTPUT RATING	DESCRIPTION	AC INPUT	LVD	FRAME	ORDERING CODE	MODEL	PHOTO
 400A	400A Infinity S Power system equipped with 8 universal positions and 26 distribution positions selectable between -48V Load and +24V Converter load System - 6RU	Dual Molex	No		150022649	NES4824-23-AC1-PS8-DC1E	
		Dual Molex	LVBD		150022648	NES4824-23-AC1-PS8-DC1E-LVBD	
 600A	600A Infinity S Power system equipped with 8 universal positions and 26 distribution positions selectable between -48V Load and +24V Converter load System - 6RU	Ind. Term Block	No		150045762	NES4824-23-AC5H-PS8-DC1E	
		Ind. Term Block	Yes		150045763	NES4824-23-AC5H-PS8-DC1E-LVBD	
		Ind. Term Block	No	84" Zone 4	150045764	NES4824-23-AC5H-PS8-DC1E-7FTR	
 600A	600A Infinity S Power system equipped with 8 universal positions and 52 total distribution positions, 26 dedicated to -48V and 26 of which are selectable between -48V Load and +24V Converter load System - 10RU	Ind. Term Block	No		150045765	NES4824-23-AC5H-PS8-DC2E	
		Ind. Term Block	LVBD		150045766	NES4824-23-AC5H-PS8-DC2E-LVBD	
		Ind. Term Block	No	84" Zone 4	150045767	NES4824-23-AC5H-PS8-DC2E-7FTR	
 600A	600A Infinity S Power system equipped with 16 universal positions and 26 distribution positions selectable between -48V Load and +24V Converter load System - 8RU	Dual Molex	No		150033376	NES4824-23-AC1-PS16-DC1E	
		Ind. Term Block	No		150045768	NES4824-23-AC5H-PS16-DC1E	
		Dual Molex	LVBD		150022650	NES4824-23-AC1-PS16-DC1E-LVBD	
		Ind. Term Block	LVBD		150045769	NES4824-23-AC5H-PS16-DC1E-LVBD	
		Ind. Term Block	No		150045770	NES4824-23-AC5H-PS16-DC1E-7FTR	
 800A	800A Infinity S Power system equipped with 16 universal positions and 52 total distribution positions, 26 dedicated to -48V and 26 of which are selectable between -48V Load and 24V Converter Load System - 12RU	Dual Molex	No		CC109172508	NES4824-23-AC1-PS16-DC2E	
		Ind. Term Block	No		150045771	NES4824-23-AC5H-PS16-DC2E	
		Dual Molex	LVBD		CC109170643	NES4824-23-AC1-PS16-DC2E-LVBD	
		Ind. Term Block	LVBD		150045772	NES4824-23-AC5H-PS16-DC2E-LVBD	
		Ind. Term Block	No	84" Zone 4	150045773	NES4824-23-AC5H-PS16-DC2E-7FTR	
		Ind. Term Block	LVBD	84" Zone 4	150045774	NES4824-23-AC5H-PS16-DC2E-LVBD-7FTR	
		Ind. Term Block	LVBD/LVLD	84" Zone 4	150045775	NES4824-23-AC5H-PS20-DC2E-LVBD-LVLD-7FTR	

Step 1: Select the Base Power System (Cont.)

Infinity S Converter Shelf, -48V Primary with +24V Secondary 19" Width



OUTPUT RATING	DESCRIPTION	ORDERING CODE	MODEL	PHOTO
 30A	Infinity S - 19" stand-alone -48V/+24V converter shelf. The shelf has individual -48V DC inputs with +24V 6-GMT fuse outputs. The shelf is rated for a maximum of 30A output. 1RU (Order Controller separately in Step 3)	150034774	J5964803L224	

Dual Voltage Infinity S Power Systems, +24V Primary with -48V Secondary 23" Width





OUTPUT RATING	DESCRIPTION	AC INPUT	LVD	FRAME	ORDERING CODE	MODEL	PHOTO
 800A	800A Infinity S Power system equipped with 8 universal positions and 26 distribution positions selectable between +24V Load and -48V Converter Load 6RU	Dual Molex	No		CC109172524	NES2448-23-AC1-PS8-DC1E	
		Ind. Term Block	No		150033378	NES2448-23-AC5-PS8-DC1E	
		Dual Molex	LVBD		CC109172516	NES2448-23-AC1-PS8-DC1E-LVBD	
		Ind. Term Block	LVBD		150033379	NES2448-23-AC5-PS8-DC1E-LVBD	
		Ind. Term Block	No		150036118	NES2448-23-AC5-PS8-DC1E-7FTR	
 800A	800A Infinity S Power system equipped with 8 universal positions and 52 total distribution positions, 26 dedicated to +24V and 26 of which are selectable between +24V Load and -48V Converter Load 10RU	Ind. Term Block	No		150033293	NES2448-23-AC5-PS8-DC2E	
		Ind. Term Block	LVBD		150033294	NES2448-23-AC5-PS8-DC2E-LVBD	
		Ind. Term Block	No		150036119	NES2448-23-AC5-PS8-DC2E-7FTR	
 900A	900A Infinity S Power system equipped with 16 universal positions and 26 distribution positions selectable between +24V Load and -48V Converter Load 8RU	Dual Molex	No		CC109163135	NES2448-23-AC1-PS16-DC1E	
		Ind. Term Block	No		150033380	NES2448-23-AC5-PS16-DC1E	
		Dual Molex	LVBD		CC109160818	NES2448-23-AC1-PS16-DC1E-LVBD	
		Ind. Term Block	LVBD		150033381	NES2448-23-AC5-PS16-DC1E-LVBD	
		Ind. Term Block	No		150036120	NES2448-23-AC5-PS16-DC1E-7FTR	
 1200A	1200A Infinity S Power system equipped with 16 universal positions and 52 total distribution positions, 26 dedicated to +24V and 26 of which are selectable between +24V Load and -48V Converter Load System - 12RU	Dual Molex	No		CC109172540	NES2448-23-AC1-PS16-DC2E	
		Ind. Term Block	No		150027197	NES2448-23-AC5-PS16-DC2E	
		Ind. Term Block	No		150027197	NES2448-23-AC5-PS16-DC2E	
		Dual Molex	LVBD		CC109172532	NES2448-23-AC1-PS16-DC2E-LVBD	
		Ind. Term Block	LVBD		150025861	NES2448-23-AC5-PS16-DC2E-LVBD	
		Ind. Term Block	No	84" Zone 4	150027198	NES2448-23-AC5-PS16-DC2E-7FTR	

Step 1: Select the Base Power System (Cont.)

Infinity S Converter Shelf, +24V Primary with -48V Secondary 19" Width

OUTPUT RATING	DESCRIPTION	ORDERING CODE	MODEL	PHOTO
 30A	Infinity S - 19" stand-alone +24V/-48V converter shelf. The shelf has individual +24V DC inputs with -48V 6-GMT fuse outputs. The shelf is rated for a maximum of 30A output. 1RU (Order Controller separately in Step 3)	150035606	J5964803L225	

RBA72 Power and Battery Cabinets

OUTPUT	ORDERING CODE	MODEL	PHOTO
	150024099	RBA72 Power Node Cabinet Includes the dual voltage Infinity S power system that is rated @ 550A N+1 and is capable of supporting 3 battery strings. (Battery Thermal Probes Included) Using 3 strings of 180Ahr batteries, the batteries will support 118.5A of load capacity.	
	150024100	RBA72-36 Supplemental Battery Cabinet Supports up to 6 strings of batteries. Battery disconnect panel in top of cabinet supports an individual 100A disconnect per battery string. Using 6 strings of 180Ahr batteries, the batteries will support 237A of load capacity. (No Battery Thermal Probes Included)	

Battery Bus Extension Kits - Used for expanding battery bus connections in single voltage systems

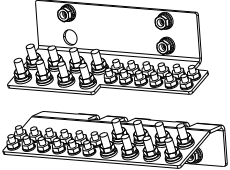
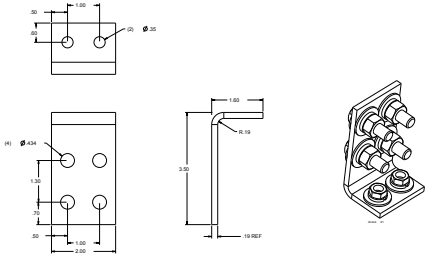
ORDERING CODE	DESCRIPTION	PHOTO
CC109172053	Bus Kit to add 10 battery connections; 4 - 5/16" on 1" and 6 - 1/4-20 on 5/8" connections. (positive and negative buses included) See Attached Drawing	
850022254	Bus Kit to expand battery bulk connections on battery buses to 2 - 3/8" on 1" through hole connections. (One bus per kit, order two for paired connections) See Attached Drawing	

Step 1: Select the Base Power System (Cont.)

Supplemental Rectifier Shelf Kits -











Used for Installing Additional Rectifier Shelves to an Infinity S System in the Field

ORDERING CODE	DESCRIPTION		PHOTO
150050584	NES AC3 19in Single Voltage Supplemental Shelf Kit	Each kit includes: Rectifier shelf with mounting hardware, busbar interconnects with hardware and inter-shelf communication cable	
150041585	NES AC5 19in Single Voltage Supplemental Shelf Kit		
150041586	NES AC6 19in Single Voltage Supplemental Shelf Kit		
150041583	NES AC1 23in Single Voltage Supplemental Shelf Kit		
150041584	NES AC5 23in Single Voltage Supplemental Shelf Kit		
150041587	NES AC1 23in Dual Voltage Supplemental Shelf Kit		
150041588	NES AC5 23in Dual Voltage Supplemental Shelf Kit		
150050606	NES AC5H 23in Single Voltage Supplemental Shelf Kit		
150050607	NES AC5H 23in Dual Voltage Supplemental Shelf Kit		

Note: Adding these shelves does not increase the overall rating of the distribution.





Step 2: Select Rectifiers and Converters

Rectifiers

OUTPUT RATING	ORDERING CODE	MODEL	PHOTO
 100A	CC109160834	95 - 145Vac input, 24V, 44A output (max. 50A@24V) 175 - 305Vac input, 24V, 100A output (max. 114A @24V) 145 - 175 linear output increase from 44A to 100A NE100AC24ATEZ	
 100A	150025075	95 - 145Vac input, 24V, 44A output (max. 50A@24V) 175 - 305Vac input, 24V, 100A output (max. 114A @24V) 145 - 175 linear output increase from 44A to 100A 100 - 310 VDC input from Solar resource with full power above 250VDC. NE100ECO24ATEZ	
 50A	CC109158878	95 - 145Vac input, 48V, 22A output (max. 25A @48V) 175 - 305Vac input, 48V, 50A output (max. 57A @48V) 145 - 175 linear output increase from 22A to 50A NE050AC48ATEZ	
 50A	150025074	95 - 145Vac input, 48V, 22A output (max. 25A @48V) 175 - 305Vac input, 48V, 50A output (max. 57A @48V) 145 - 175 linear output increase from 22A to 50A 100 - 310 VDC input from Solar resource with full power above 250VDC. NE050ECO48ATEZ	
 75A	CC109163473	95 - 145Vac input, 48V, 22A output (max. 25A@48V) 175 - 305Vac input, 48V, 75A output (max. 82A@48V) 145 - 175 linear output increase from 22A to 75A Note: for use in 19" or AC5H 23" systems only NE075AC48ATEZ	

Step 2: Select Rectifiers and Converters (Cont.)

Converters

OUTPUT RATING	ORDERING CODE	MODEL	PHOTO
 30A	CC109112471	21-30Vdc input, 48V, 30A output NE030DC48A	
 40A	150023619	21-30Vdc input, 48V, 40A output NE040DC48AZ	
 75A	CC109142881	42-60Vdc input, 24V, 75A output NE075DC24A	

Miscellaneous

ORDERING CODE	MODEL
CC109170668	Infinity Rectifier/Converter slot filler (full chassis)
CC848798702	Blank panel for use in empty rectifier / converter positions

Step 3: Select Controller

For Infinity S Converter Shelves only, select a Pulsar Edge controller for managing and monitoring of the converter shelf.

ORDERING CODE	DESCRIPTION	MODEL
150036348	Pulsar Edge Controller with 6 output relays, USB port, and Display	NE841E_016R_USB_DS
150041556	Pulsar Edge Controller with 6 output relays, USB port and NO graphic display)	CNTL_NE841E_016R_USB_S
150039541	Pulsar Edge Controller with 3 input and 3 output relays, USB port and NO graphic display.	CNTL_NE841E_3C3R_USB_S

Step 4: Select AC Accessories

Example: 208/240VAC for a NES48-AC1-PS4-DC1E-LVBD shelf using 50A rectifiers would use a 848710711 AC 8 gauge which provides 2 AC cords; enough to power 4 rectifiers. Customer should provide one 40A protecting circuit breaker per two rectifiers. For AC3 cable sets, it is recommended that a 20A circuit breaker is used per rectifier. Note: If PS# of your shelf model number is not listed in table, choose the next higher number. AC cords are 10 feet long and unterminated on the end. See optional accessories for twist lock connectors.

ORDERING CODE	AC TYPE	GAUGE	SHELF TERMINATION	ORDER # OF CORDS			CORD TYPE	LENGTH	USER TERMINATION	120 VAC	208/240 VAC
				SHELF	DUAL	INDIV.					
CC848801977	AC1	8	Molex	1	x		Sleeved	3'	Unterminated	x	x
CC848830522			Molex	1	x		Sleeved	4'	Unterminated		
848710711			Molex	1	x		Sleeved	10'	Unterminated		
CC848906586			Molex	2	x		SO	10'	Unterminated		
CC848773515		10	Molex	2	x		SO	15'	Unterminated		
850031034		8	Molex	2	x		SO		Unterminated		
CC848847368	AC3	12	IEC - No Plug	4		x	SO	8'	Unterminated	x	x
CC848850801		12	IEC 5 - 20P	4		x	SO	8'	5 -20P	x	
CC848850834		12	IEC 6 - 20P	4		x		8'	6 -20P		x
CC848850842		12	IEC L6 - 20P	4		x		8'	L6 -20P		x

The following AC Covers can be used to replace the individual AC Covers on the 23" AC5 or AC5H shelf with a single larger cover to allow for fewer conduit runs to the system. Each Kit comes with 2 covers, one for each side of the system.

ORDERING CODE	AC COVER KIT
150037979	2 Shelf AC Cover Kit
150037980	3 Shelf AC Cover Kit
150037981	4 Shelf AC Cover Kit

Step 5: Select Alarm Cables







Alarm Cables

ORDERING CODE	MODEL	PHOTO
CC848865980	15ft Auxiliary input alarm cable for Pulsar Plus Controller	
CC848817651	50ft Auxiliary input alarm cable for Pulsar Plus Controller	
CC848817668	150ft Auxiliary input alarm cable for Pulsar Plus Controller	
CC109157442	15ft alarm cable for Pulsar Plus Controller	
CC848817635	50ft alarm cable for Pulsar Plus Controller	
CC848817643	150ft alarm cable for Pulsar Plus Controller	
CC848890161	5ft alarm cable for Pulsar Edge Controller	
CC848890178	15ft alarm cable for Pulsar Edge Controller	
CC848890186	50ft alarm cable for Pulsar Edge Controller	

Step 6: Select Distribution Components

Infinity S systems all support plug-in (bullet style) breakers or fuse modules. Larger breakers can be 2 or even 3 poles. The multi-pole breakers **MUST** be used with the appropriate multi-pole adapter to parallel the poles for proper operation.

Bullet Style Load Circuit Breakers

ORDERING CODE	AMPERAGE	CB POSITIONS (POLES)	MIN WIRE GAUGE	PHOTO
407998137	3	1	10	
407998145	5	1	10	
407998152	10	1	10	
407998160	15	1	10	
407998178	16	1	10	
407998186	20	1	10	
407998194	25	1	10	
407998202	30	1	10	
408213486	40	1	8	
407998210	45	1	8	
407998228	50	1	6	
407998236	60	1	6	
407998244	70	1	2	
407998251	80	1	2	
407998269	90	1	2	
407998277	100	1	2	
CC848808551	100	2	2	
408185353	125	2	2	
408185346	150	2	1/0	
408564941	200	3	2/0	
CC408573975	225	3	4/0	
408535752	250	3	4/0	
CC848756916	2-pole Adapter bus for 100-150A breakers; used for 1/4"-20 on 5/8" lugs (order 2 per 2 pole breaker to accommodate load and return lugs)			
850021775	2-pole Adapter bus for 100-150A breakers; used for 3/8" on 1" lugs (order 2 per 2 pole breaker to accommodate load and return lugs)			
CC848756924	3-pole Adapter bus for 200-250A breakers; used for 3/8" on 1" lugs; off-center connection (order 2 per 3 pole breaker to accommodate load and return lugs)			
850021955	3-pole Adapter bus for 200-250A breakers; used for 3/8" on 1" lugs; center connection (order 2 per 3 pole breaker to accommodate load and return lugs)			

Note: For 70-100A single pole breakers, one breaker space must be left open in the adjacent position when powering breaker above 80% capacity under normal loading conditions

Step 6: Select Distribution Components (Cont.)

Bullet Battery Circuit Breakers (Yellow Handle) (Alarms on Mid-Trip and in Off Position)

ORDERING CODE	AMPERAGE	PHOTO
CC408612758	30	
CC408612766	40	
CC408612774	45	
CC408574370	50	
408560123	60	
CC408574387	70	
CC408574395	100	
CC408574404	125 (2-pole)	
CC408574412	150 (2-pole)	
CC408574420	200 (2-pole)	
CC408645295	250A (3-pole)	
CC109106548	100A battery bullet bus strap (substitute for battery breaker)	

Bullet Style Fuse Holder and TPS Fuses

ORDERING CODE	AMPERAGE	WP-92461 LIST	MIN WIRE GAUGE	PHOTO
406700567	3	100	10	
406700583	5	101	10	
406700591	6	102	10	
406700609	10	103	10	
406700617	15	104	10	
406700625	20	105	10	
406700633	25	106	10	
406700641	30	107	10	
406700658	40	108	10	
406700674	50	109	8	
406700682	60	110	6	
406700690	70	111	6	
402328926	0.18 Alarm Fuse			
408548944	Bullet Fuse Holder, TFD-101-011-09 (Alarms on Blown Fuse or Fuse Head Removal)			
CC408617410	Bullet Fuse Holder, TFD-101-011-10 (Alarms on Blown Fuse Only)			

Step 6: Select Distribution Components (Cont.)

Bullet Style GMT Fuse Holder and GMT Fuses

ORDERING CODE	AMPERAGE	PHOTO
405006222	0.25A	
3150439	0.5A	
405673146	1.33A	
405181983	2A	
406976985	3A	
406159061	5A	
405725433	7.5A	
406159236	10A	
407845197	12A	
406473959	15A	
CC109103157	6-pos GMT Bullet Fuse Holder (Requires 2 bullet positions) 12A max. fuse	
408515823	Fuse Puller	
402099436	Dummy Fuse	

Terminal Lugs for Bullet Style Breakers and TPS Fuses (1/4" Bolt on 5/8" Centers)

ORDERING CODE	STR WIRE GA (CLASS B)	FLEX WIRE GA (CLASS I)	WP-91412 LIST	PHOTO
406021626	8	8	75	
405347519	6	6	3	
405347576	4	4	5	
405348202	2	-	54	
405347683	-	2	8	

Terminal Lugs for Battery and Large Breakers (3/8" Bolt on 1" Centers)

PEOPLESOFT NUMBER	STR WIRE GA (CLASS B)	FLEX WIRE GA (CLASS I)	WP-91412 LIST	PHOTO
406338665	2	-	-	
405348228	1/0	-	-	
405348236	2/0	1/0	-	
406021725	-	2/0	-	
405348251	4/0	-	-	
405347923	-	4/0	-	

Step 7: Select Battery Monitoring

ORDERING CODE	DESCRIPTION	PHOTO	
CC109142980	QS873A Thermal Probe (A)		
150026698	QS873B Ambient Thermal Probe (A)		
CC848817024	10 ft wire set		(B: thermal probe to controller)
CC109157434	20 ft wire set		(B: thermal probe to controller)
CC848822560	1 ft wire set		(C: thermal probe to thermal probe)
848719803	5 ft wire set		(C: thermal probe to thermal probe)
CC848822321	10 ft wire set		(C: thermal probe to thermal probe)
850027334	20 ft wire set (C: thermal probe to thermal probe)		
108958422	ES771A Battery Voltage Monitor Card		
CC848791517	2-1/2 ft wire set		(D: ES771A to thermal probe)
CC848797290	6 ft wire set	(D: ES771A to thermal probe)	
848719829	10 ft wire set	(D: ES771A to thermal probe)	
CC848791500	4 ft wire set	(G: ES771A to ES771A or controller)	
848652947	10 ft wire set	(G: ES771A to ES771A or controller)	
555052-1	In-Line Coupler (for extending item G above)		



Temperature/Voltage probes are needed for battery monitoring. They are connected to each battery or battery string to provide slope thermal compensation, temperature alarms and voltage imbalance alarms.

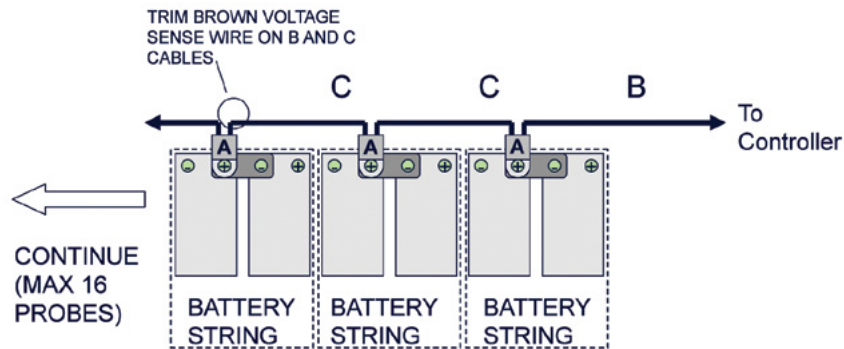

Temperature Measurement

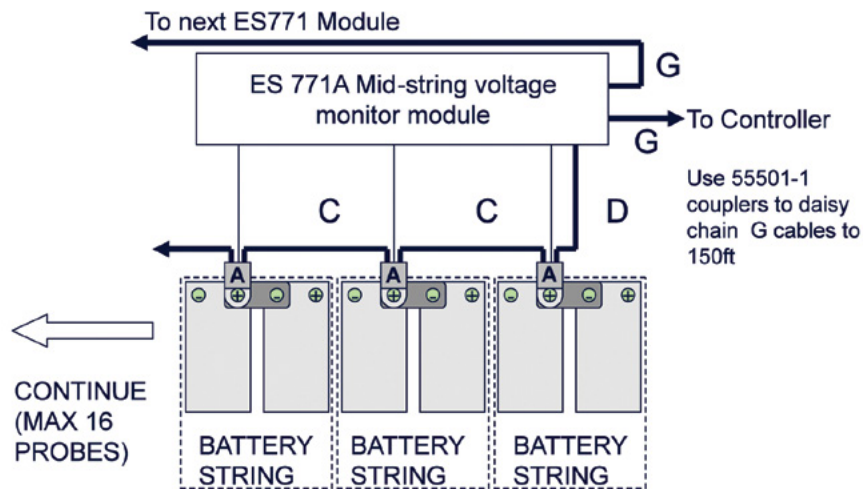

Temperature and Voltage Measurement

Reliability

- Distributed fault tolerance
- Proven field performance
- Controller continuity

Intelligence

- Industry leading controller features
- Ethernet interface for remote access
- Centralized network management

Investment Protection

- Module Compatibility
- Secondary Voltage flexibility +24V / -48V
- Flexible Upgrade Options

On Time Delivery

- Standard building blocks
- 4 - 6 week availability
- 24/7 technical support

Management Visibility

Galaxy Manager* software is the centralized visibility and control component of a comprehensive power management system designed to meet engineering, operations and maintenance needs. The Galaxy Manager client-server architecture enables remote access to system controllers across the power network.

- Dashboard display with one-click access to management information database
- Trend analysis
- Scheduled or on demand reports
- Fault, configuration, asset, and performance management

Training

GE offers on-site and classroom training options based on certification curriculum. Technical training can be tailored to individual customer needs. Training enables customers and partners to more effectively manage and support the power infrastructure. We have built our training program on practical learning objectives that are relevant to specific technologies or infrastructure design objectives.

Service & Support

GE field service and support personnel are trusted advisors to our customers – always available to answer questions and help with any project, large or small. Our certified professional services team consists of experts in every aspect of power conversion with the resources and experience to handle large turnkey projects along with custom approaches to complex challenges. Proven systems engineering and installation best practices are designed to safely deliver results that exceed our customers' expectations.

Warranty

GE is committed to providing quality products and solutions. We have developed a comprehensive warranty that protects you and provides a simple way to get your products repaired or replaced as soon as possible.

For full warranty terms and conditions please go to www.gecriticalpower.com.