

Application Note

AN- EVAL-2QR0665G-28W

28W16V Evaluation Board with Quasi-Resonant CoolSET[®] ICE2QR0665G

Power Management & Supply



**Published by
Infineon Technologies AG
81726 Munich, Germany
© 2012 Infineon Technologies AG
All Rights Reserved.**

Legal Disclaimer

The information given in this document shall in no event be regarded as a guarantee of conditions or characteristics. With respect to any examples or hints given herein, any typical values stated herein and/or any information regarding the application of the device, Infineon Technologies hereby disclaims any and all warranties and liabilities of any kind, including without limitation, warranties of non-infringement of intellectual property rights of any third party.

Information

For further information on technology, delivery terms and conditions and prices, please contact the nearest Infineon Technologies Office (www.infineon.com).

Warnings

Due to technical requirements, components may contain dangerous substances. For information on the types in question, please contact the nearest Infineon Technologies Office. Infineon Technologies components may be used in life-support devices or systems only with the express written approval of Infineon Technologies, if a failure of such components can reasonably be expected to cause the failure of that life-support device or system or to affect the safety or effectiveness of that device or system. Life support devices or systems are intended to be implanted in the human body or to support and/or maintain and sustain and/or protect human life. If they fail, it is reasonable to assume that the health of the user or other persons may be endangered.

Title

Revision History: **1 March 2013** **V1.1**

Previous Version: V1.0

Page	Subjects (major changes since last revision)
10, 12	Revise typo in circuit code R11

28W16V Evaluation Board with Quasi-Resonant CoolSET[®] ICE2QR0665G
License to Infineon Technologies Asia Pacific Pte Ltd

AN-PS0071

Kok Siu Kam EricEric.kok@infineon.com**Wong Siew Teng Winson**Winson.wong@infineon.com**We Listen to Your Comments**

Any information within this document that you feel is wrong, unclear or missing at all?
Your feedback will help us to continuously improve the quality of this document.

Please send your proposal (including a reference to this document) to:

comments@infineon.com



Table of Contents

1	Content	6
2	Evaluation Board	6
3	List of Features	6
4	Technical Specifications	7
5	Circuit Description.....	7
5.1	Mains Input and Rectification.....	7
5.2	Integrated MOSFET and PWM Control.....	7
5.3	Output Stage	7
5.4	Feedback Loop.....	7
6	Circuit Operation	7
6.1	Startup Operation.....	7
6.2	Normal Mode Operation.....	8
6.3	Primary side peak current control.....	8
6.4	Digital Frequency Reduction	8
6.5	Burst Mode Operation.....	8
7	Protection Features	8
7.1	Vcc under voltage and over voltage protection.....	8
7.2	Foldback point protection.....	8
7.3	Open loop/over load protection.....	9
7.4	Adjustable output overvoltage protection	9
7.5	Short winding protection	9
7.6	Auto restart for over temperature protection.....	9
8	Circuit diagram	10
8.1	PCB Top overlay	11
8.2	PCB Bottom Layer	11
9	Component List	12
10	Transformer Construction	13
11	Test Results	14
11.1	Efficiency and standby performance	14
11.2	ESD Test.....	16
11.3	Lightning Surge Test	16
11.4	EMI performance.....	16
11.4.1	115Vac Line & Neutral	16
11.4.2	230Vac Line & Neutral	17
12	Waveform and scope plots	18
12.1	Startup @85Vac and 28W load	18
12.2	Working at different zero crossing point	18
12.3	Burst mode operation	19
12.4	Protection modes.....	19
13	References	20

1 Content

This application note is a description of 28W switching mode power supply evaluation board designed in a quasi resonant flyback converter topology using ICE2QR0665G Quasi-resonant CoolSET[®]. The target application of ICE2QR0665G is for set-top box, portable game controller, DVD player, netbook adapter and auxiliary power supply for LCD TV, etc. With the CoolMOS[®] integrated in this IC, it greatly simplifies the design and layout of the PCB. Due to valley switching, the turn on voltage is reduced and this offers higher conversion efficiency comparing to fixed frequency hard-switching flyback converter. With the DCM mode control, the reverse recovery problem of secondary rectify diode is relieved. And for its natural frequency jittering with line voltage, the EMI performance is better. Infineon's digital frequency reduction technology enables a quasi-resonant operation till very low load. As a result, the system efficiency over the entire load range is significantly improved compared to conventional free running quasi resonant converter which implements with only maximum switching frequency limitation at light load. In addition, numerous adjustable protection functions have been implemented in ICE2QR0665G to protect the system and customize the IC for the chosen application. In case of failure modes, like open control-loop/over load, output overvoltage, and transformer short winding, the device switches into **Auto Restart Mode** or **Latch-off Mode**. By means of the cycle-by-cycle peak current limitation plus foldback point correction, the dimension of the transformer and current rating of the secondary diode can both be optimized. Thus, a cost effective solution can be easily achieved.

2 Evaluation Board



Figure 1-EVALQR-28W-ICE2QR0665G

3 List of Features

650V avalanche rugged CoolMOS [®] with built in depletion startup cell
Quasi-resonant operation
Digital frequency reduction with decreasing load
Cycle-by-cycle peak current limitation with foldback point correction
Built-in digital soft-start
Direct current sensing with internal Leading Edge Blanking Time
VCC under voltage protection: IC stop operation, recover with softstart
VCC over voltage protection: IC stop operation, recover with softstart
Openloop/Overload protection: Auto Restart
Output overvoltage protection: Latch-off with adjustable threshold
Short-winding protection: Latch-off
Over temperature protection: Autorestart

4 Technical Specifications

Input voltage	85Vac~265Vac
Input frequency	50Hz, 60Hz
Output voltage and current	16V 1.75A
Output power	28W
Average Efficiency	>85% at full load
Standby power	<100mW@no load
Minimum switching frequency at full load, minimum input voltage	65kHz

5 Circuit Description

5.1 Mains Input and Rectification

The AC line input side comprises the input fuse F1 as over current protection. The X2 Capacitors C1, C2 and Choke L1 form a main filter to minimize the feedback of RFI into the main supply. After the bridge rectifier BR1, together with a smoothing capacitor C3, provide a voltage of 70VDC to 380 VDC depending on mains input voltage.

5.2 Integrated MOSFET and PWM Control

ICE2QR0665G is comprised of a power MOSFET and the quasi-resonant controller; this integrated solution greatly simplifies the circuit layout and reduces the cost of PCB manufacturing. The PWM switch-on is determined by the zero-crossing input signal and the value of the up/down counter. The PWM switch-off is determined by the feedback signal V_{FB} and the current sensing signal V_{CS} . ICE2QR0665G also performs all necessary protection functions in flyback converters. Details about the information mentioned above are illustrated in the product datasheet.

5.3 Output Stage

On the secondary side, 16V output, the power is coupled out via a schottky diode D3. The capacitors C11, C16 provides energy buffering followed by the L-C filters L2 and C12 to reduce the output ripple and prevent interference between SMPS switching frequency and line frequency considerably. Storage capacitors C11, C16 are designed to have an internal resistance (ESR) as small as possible. This is to minimize the output voltage ripple caused by the triangular current.

5.4 Feedback Loop

For feedback, the output is sensed by the voltage divider of R10, R11 and R12 and compared to TL431 internal reference voltage. C14, C15 and R8 comprise the compensation network. The output voltage of TL431 is converted to the current signal via optocoupler IC2 and two resistors R6 and R7 for regulation control.

6 Circuit Operation

6.1 Startup Operation

Since there is a built-in startup cell in the ICE2QR0665G, there is no need for external start up resistor, which can improve standby performance significantly.

When VCC reaches the turn on voltage threshold 18V, the IC begins with a soft start. The soft-start implemented in ICE2QR0665G is a digital time-based function. The preset soft-start time is 12ms with 4 steps. If not limited by other functions, the peak voltage on CS pin will increase step by step from 0.32V to 1V finally. After IC turns on, the Vcc voltage is supplied by auxiliary windings of the transformer.

6.2 Normal Mode Operation

The secondary output voltage is built up after startup. The secondary regulation control is adopted with TL431 and optocoupler. The compensation network C14, C15 and R8 constitute the external circuitry of the error amplifier of TL431. This circuitry allows the feedback to be precisely controlled with respect to dynamically varying load conditions, therefore providing stable control.

6.3 Primary side peak current control

The MOSFET drain source current is sensed via external resistor R5 and R5A. Since ICE2QR0665G is a current mode controller, it would have a cycle-by-cycle primary current and feedback voltage control which can make sure the maximum power of the converter is controlled in every switching cycle.

6.4 Digital Frequency Reduction

During normal operation, the switching frequency for ICE2QR0665G is digitally reduced with decreasing load. At light load, the MOSFET will be turned on not at the first minimum drain-source voltage time, but on the n^{th} . The counter is in range of 1 to 7, which depends on feedback voltage in a time-base. The feedback voltage decreases when the output power requirement decreases, and vice versa. Therefore, the counter is set by monitoring voltage V_{FB} . The counter will be increased with low V_{FB} and decreased with high V_{FB} . The thresholds are preset inside the IC.

6.5 Burst Mode Operation

At light load condition, the SMPS enters into Active Burst Mode. At this stage, the controller is always active but the V_{CC} must be kept above the switch off threshold. During active burst mode, the efficiency increase significantly and at the same time it supports low ripple on V_{out} and fast response on load jump.

For determination of entering Active Burst Mode operation, three conditions apply:

1. the feedback voltage is lower than the threshold of V_{FBEB} (1.25V). Accordingly, the peak current sense voltage across the shunt resistor is 0.17;
2. the up/down counter is 7;
3. and a certain blanking time, 24ms (t_{BEB}).

Once all of these conditions are fulfilled, the Active Burst Mode flip-flop is set and the controller enters Active Burst Mode operation. This multi-condition determination for entering Active Burst Mode operation prevents mis-triggering of entering Active Burst Mode operation, so that the controller enters Active Burst Mode operation only when the output power is really low during the preset blanking time.

During active burst mode, the maximum current sense voltage is reduced from 1V to 0.34V so as to reduce the conduction loss and the audible noise. At the burst mode, the FB voltage is changing like a sawtooth between 3.0 and 3.6V. The switching frequency is set to a fix frequency of 52kHz.

The feedback voltage immediately increases if there is a high load jump. This is observed by one comparator. As the current limit is 34% during Active Burst Mode a certain load is needed so that feedback voltage can exceed V_{FBLB} (4.5V). After leaving active burst mode, maximum current can now be provided to stabilize V_{O} . In addition, the up/down counter will be set to 1 immediately after leaving Active Burst Mode. This is helpful to decrease the output voltage undershoot

7 Protection Features

7.1 Vcc under voltage and over voltage protection

During normal operation, the V_{CC} voltage is continuously monitored. When the V_{CC} voltage falls below the under voltage lock out level (V_{VCCoff}) or the V_{CC} voltage increases up to V_{CCOVP} , the IC will enter into auto restart mode.

7.2 Foldback point protection

For a quasi-resonant flyback converter, the maximum possible output power is increased when a constant current limit value is used for all the mains input voltage range. This is usually not desired as this will increase additional cost on transformer and output diode in case of output over power conditions.

The internal fold back protection is implemented to adjust the V_{CS} voltage limit according to the bus voltage. Here, the input line voltage is sensed using the current flowing out of ZC pin during the MOSFET on-time. As the result, the maximum current limit will be lower at high input voltage and the maximum output power can be well limited versus the input voltage.

7.3 Open loop/over load protection

In case of open control loop, feedback voltage is pulled up with internally block. After a fixed blanking time 30ms, the IC enters into auto restart mode. In case of secondary short-circuit or overload, regulation voltage V_{FB} will also be pulled up, same protection is applied and IC will auto restart.

7.4 Adjustable output overvoltage protection

During off-time of the power switch, the voltage at the zero-crossing pin ZC is monitored for output overvoltage detection. If the voltage is higher than the preset threshold 3.7V for a preset period 100 μ s, the IC is latched off.

7.5 Short winding protection

The source current of the MOSFET is sensed via two shunt resistors R5 and R5A in parallel. If the voltage at the current sensing pin is higher than the preset threshold V_{CSSW} of 1.68V during the on-time of the power switch, the IC is latched off. This constitutes a short winding protection. To avoid an accidental latch off, a spike blanking time of 190ns is integrated in the output of internal comparator.

7.6 Auto restart for over temperature protection

The IC has a built-in over temperature protection function. When the controller's temperature reaches 130 °C, the IC will shut down switch and enters into auto restart. This can protect power MOSFET from overheated.

8 Circuit diagram

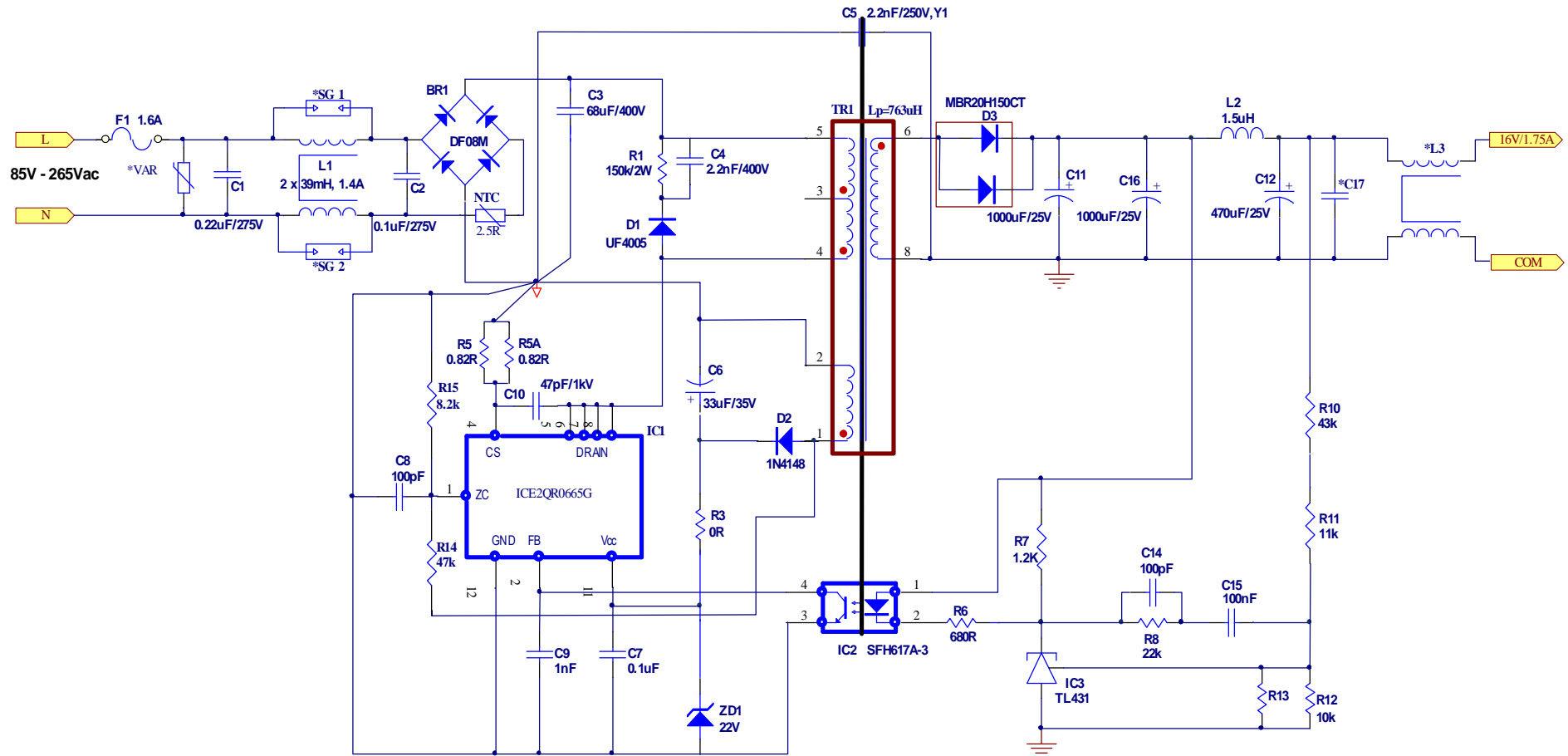

28W 16V SMPS Demoboard with ICE2QR0665G

Figure 2 – Schematics

8.1 PCB Top overlayer

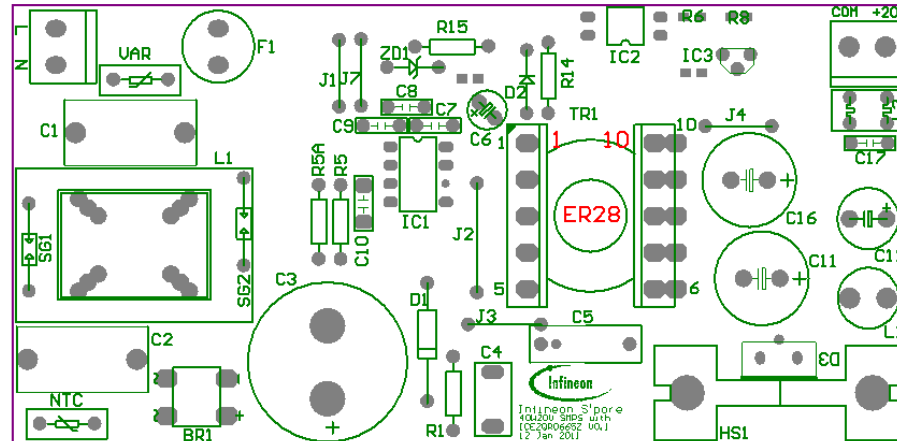

Figure 3 –Component Legend – View from topside

8.2 PCB Bottom Layer

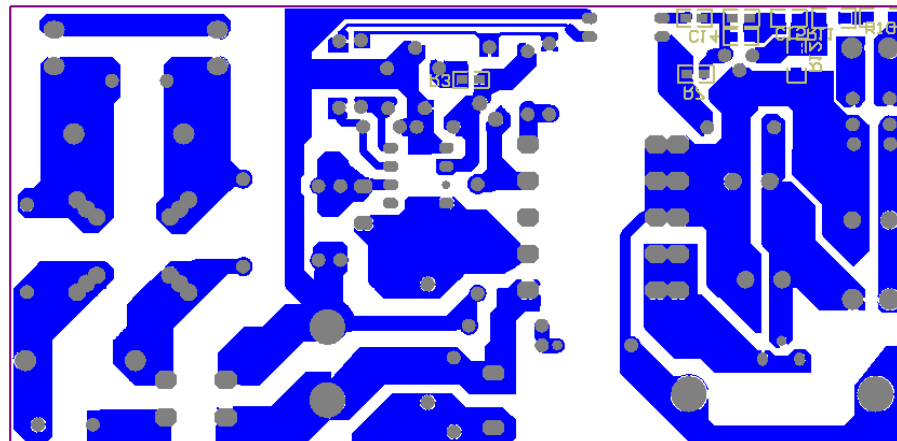

Figure 4 Solder side copper – View from bottom side

9 Component List

Items	Circuit Code	Part Type	Part no.	Manufacturer
1	BR1	1.5A/800V	DF08M	Vishay
2	NTC	2.5Ω S236	B57236S0259M000	Epcos
3	C1	0.22μF/275Vac X2	B32922C3224K000	Epcos
4	C2	0.1μF/275Vac X2	B32922C3104K000	Epcos
5	C3	68μF/400V	B43501A9686M000	Epcos
6	C4	2.2nF/400V	B32529C8222K000	Epcos
7	C5	2.2nF/250V, Y1	DE1E3KX222MA4BL01	Murata
8	C6	33μF/35V	B41851A7336M000	Epcos
9	C7	0.1μF	RPER71H104K2K1A03B	Murata
10	C8	100pF		
11	C9	1nF	RPER71H102K2K1A03B	Murata
12	C10	47pF/1000V		
13	C11	1000μF/25V		
14	C12	470μF/25V		
15	C14	100pF(0805)		
16	C15	100nF(0805)		
17	C16	1000μF/25V		
18	D1	UF4005	UF4005	Vishay
19	D2	1N4148		
20	D3	20A/150V	MBR20H150CT	Vishay
21	F1	1.6A Fuse		
22	FB1	Ferrite Bead		
23	IC1	ICE2QR0665G (QR CoolSET; R _{dson} =0.65Ω, DSO-16/12 package)	ICE2QR0665G	Infineon
24	IC2	SFH617A-3		
25	IC3	TL431		
26	J1~J7	Jumper		
27	L1	2X39mH,1.4A	B82734R2142B030	Epcos
28	L2	1.5μH		
29	R1	150kΩ/2W		
30	R3	0Ω, (SMD 0805)		
31	R5	0.82Ω(0.5W, 1%)		
32	R5A	0.82Ω(0.5W, 1%)		
33	R6	680Ω(SMD 0805)		
34	R7	1.2kΩ(SMD 0805)		
35	R8	22kΩ(SMD 0805)		
36	R10	43kΩ,0.1% (1206)		
37	R11	11kΩ,1%(1206)		
38	R12	10kΩ(1%)(1206)		
39	R14	47kΩ		
40	R15	8.2kΩ		
41	TR1	534μH	PC40EER28-Z	
42	ZD1	22V		

Table 1– Component List

10 Transformer Construction

Core and material: PC40EER28-Z

Bobbin: Horizontal Version, BEER-28-1110CP

Primary Inductance, $L_p=763\mu\text{H}$, measured between pin 5 and pin 4 (Gapped to Inductance)

Air Gap in center leg

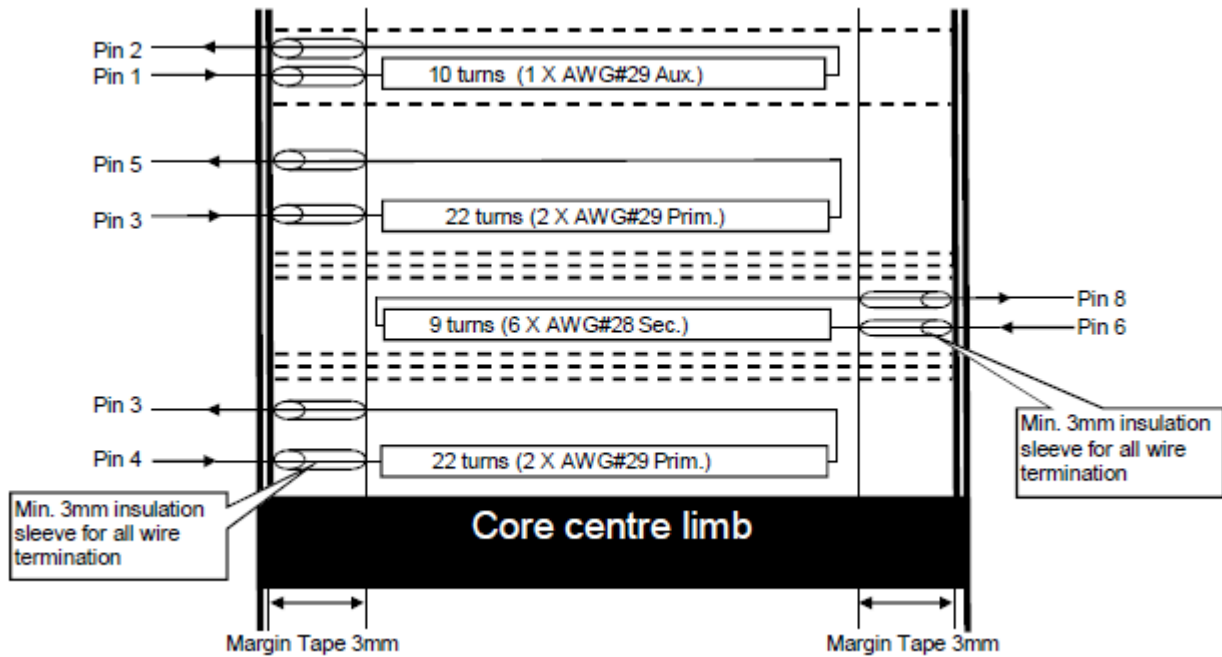

Figure 5 – Transformer structure

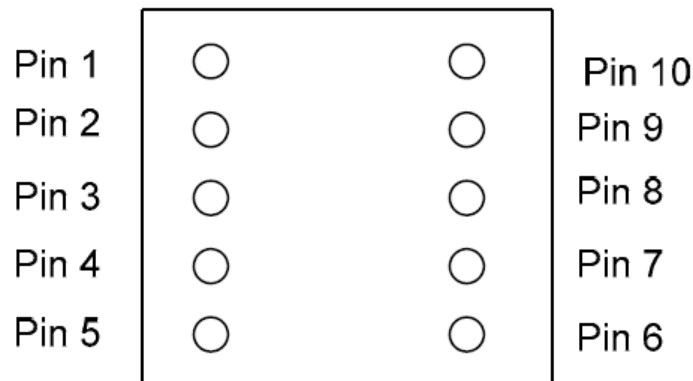

Figure 6 – Transformer complete – top view

Start	Stop	No. of turns	Wire size	Layer
1	2	10	1XAWG#29	Auxiliary
3	5	22	2XAWG#29	$\frac{1}{2}$ Primary
6	8	9	6XAWG#28	Secondary
4	3	22	2XAWG#29	$\frac{1}{2}$ Primary

Table 2 wire gauge used of the transformer windings

11 Test Results

11.1 Efficiency and standby performance

Voltage (Vac)	Input Power (W)	Output Voltage (V)	Output Current (A)	Output Power (W)	Efficiency (%)
85	7.96	16.24	0.43	7.03	88.36
85	16.08	16.24	0.87	14.07	87.48
85	24.35	16.24	1.30	21.10	86.66
85	32.63	16.24	1.73	28.14	86.23
115	7.92	16.24	0.43	7.03	88.81
115	15.86	16.24	0.87	14.07	88.7
115	23.78	16.24	1.30	21.10	88.73
115	31.85	16.24	1.73	28.14	88.34
150	7.99	16.24	0.43	7.03	88.03
150	15.79	16.24	0.87	14.07	89.09
150	23.57	16.24	1.30	21.10	89.52
150	31.60	16.24	1.73	28.14	89.04
180	7.82	16.24	0.43	7.03	89.94
180	15.74	16.24	0.87	14.07	89.37
180	23.62	16.24	1.30	21.10	89.33
180	31.36	16.24	1.73	28.14	89.72
230	8.20	16.24	0.43	7.03	85.77
230	15.87	16.24	0.87	14.07	88.64
230	23.67	16.24	1.30	21.10	89.15
230	31.40	16.24	1.73	28.14	89.6
264	8.30	16.24	0.43	7.03	84.74
264	16.31	16.24	0.87	14.07	86.25
264	24.27	16.24	1.30	21.10	86.94
264	32.30	16.24	1.73	28.14	87.11

Table 3 – Efficiency vs. Load

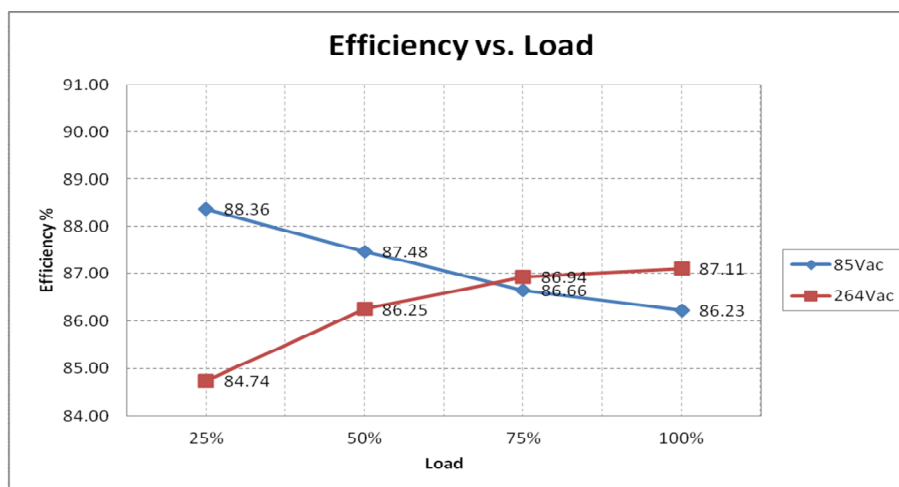

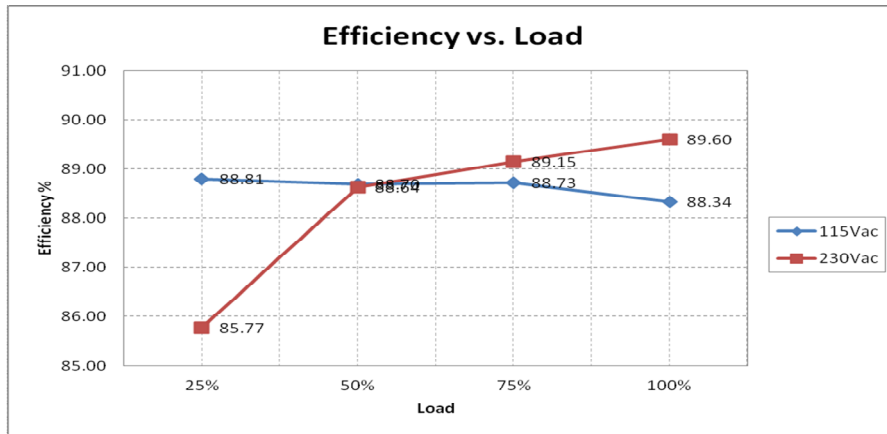

Figure 7 – Efficiency vs. Output Load

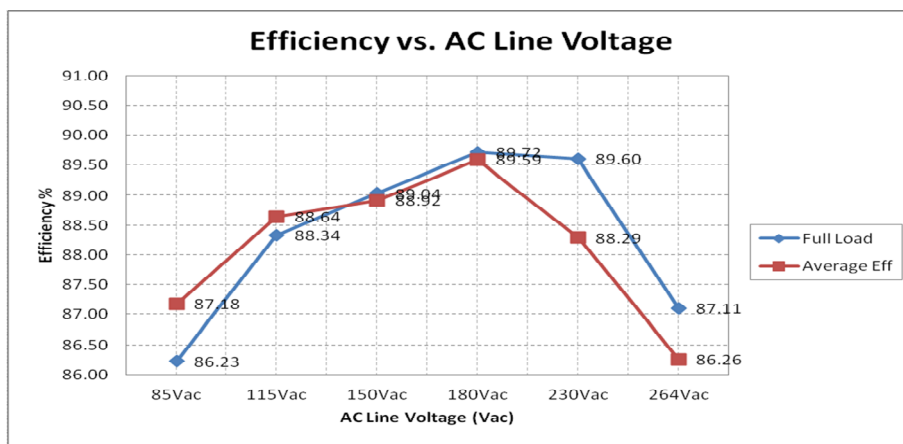

Figure 8 Efficiency vs AC line voltage

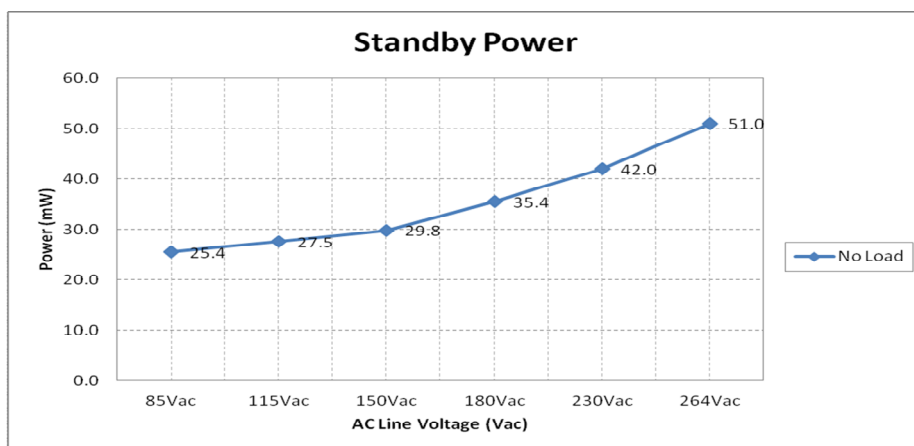

Figure 9 Standby input power vs AC line voltage

11.2 ESD Test

Pass* (EN61000-4-2): 20kV for contact discharge.

*Add L22 and C24

11.3 Lightning Surge Test

Pass* (EN61000-4-5) 3kV for line to earth

*Without adding any spark gap.

11.4 EMI performance

11.4.1 115Vac Line & Neutral

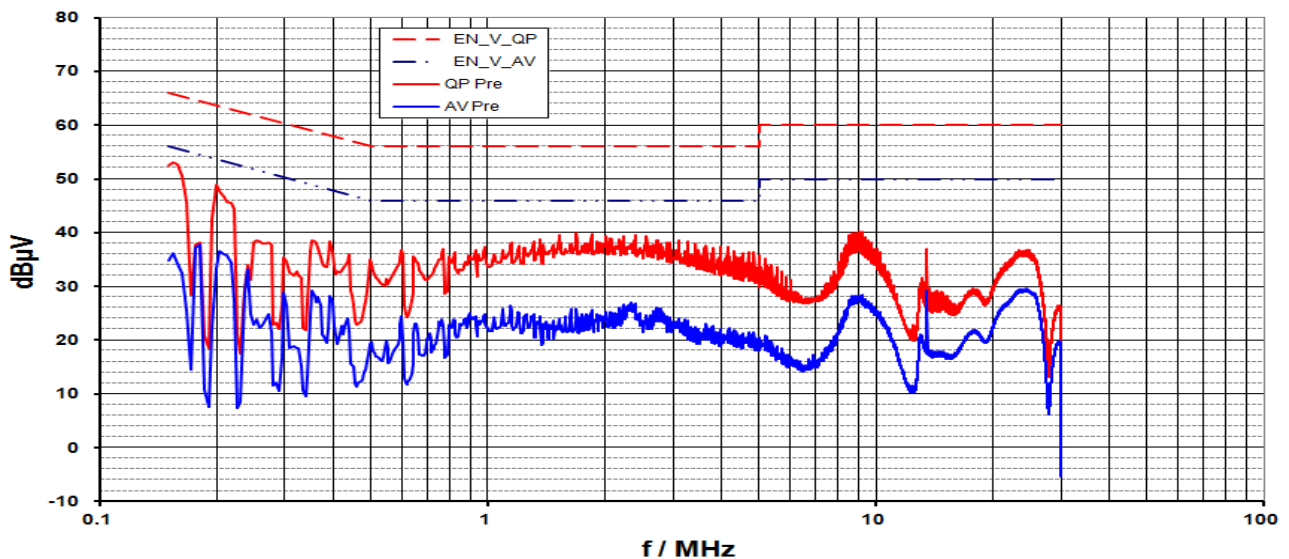

Figure 10 EMI plot for 115Vac Line

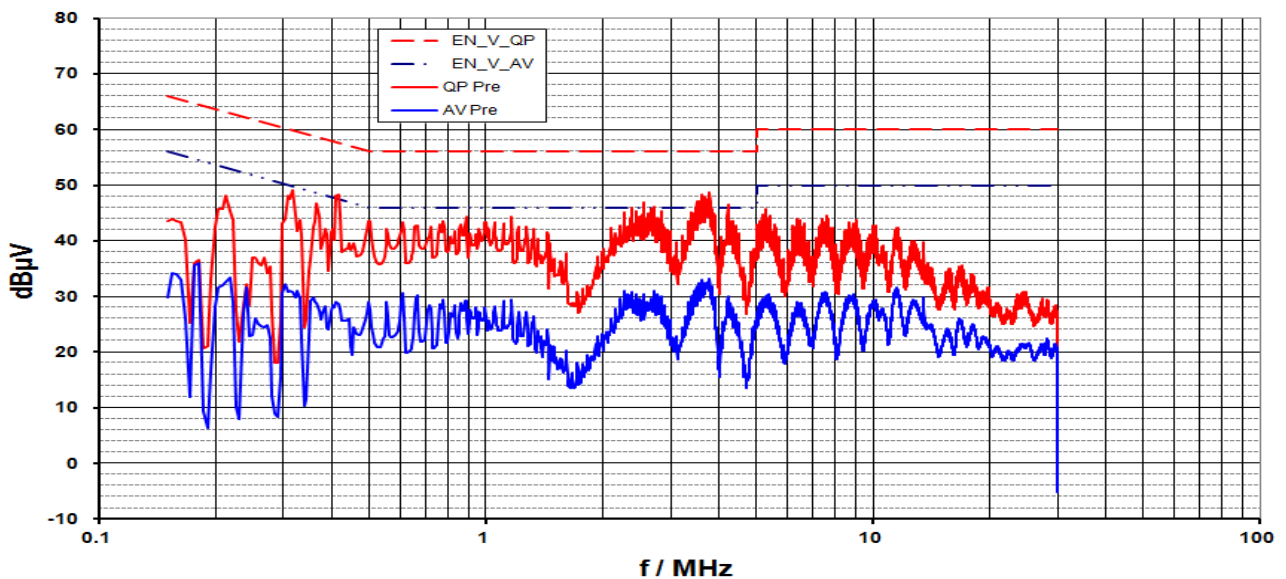

Figure 11 EMI plot for 115Vac Neutral

11.4.2 230Vac Line & Neutral

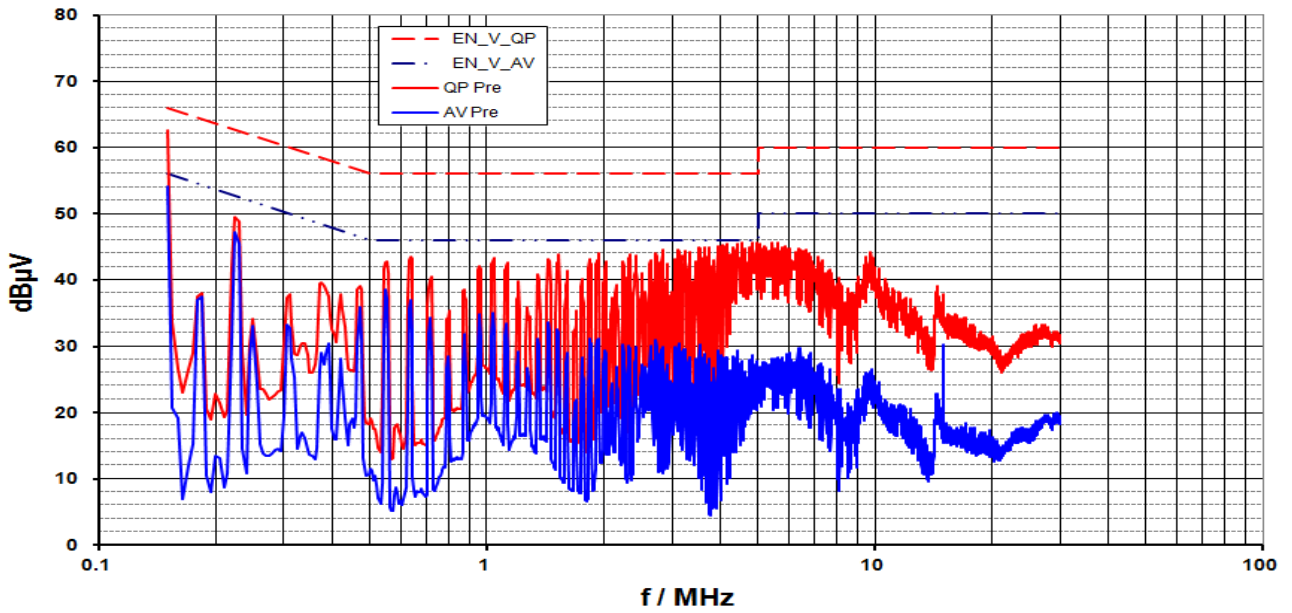

Figure 12 EMI plot for 230Vac Line

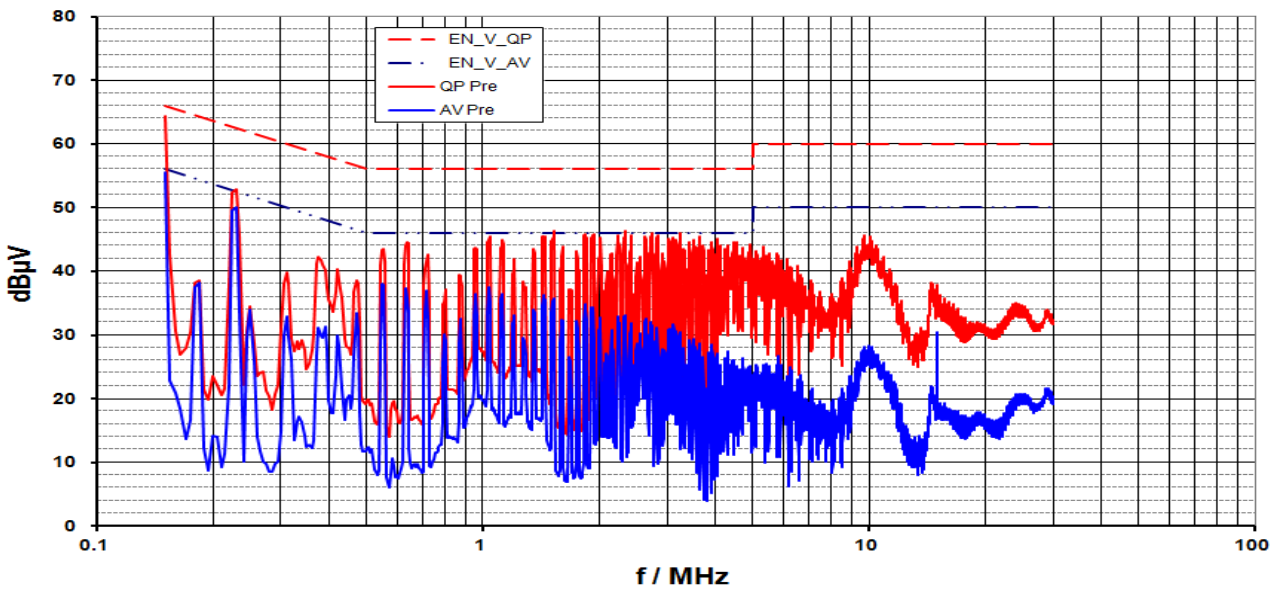

Figure 13 EMI plot for 230Vac Neutral

Remarks:

One of the suggestions to improve the EMI performance on 230Vac low frequency is to increase the capacitance on the XCAP.

12 Waveform and scope plots

All waveform and scope were recorded with LeCroy 44Xi oscilloscope.

12.1 Startup @85Vac and 28W load

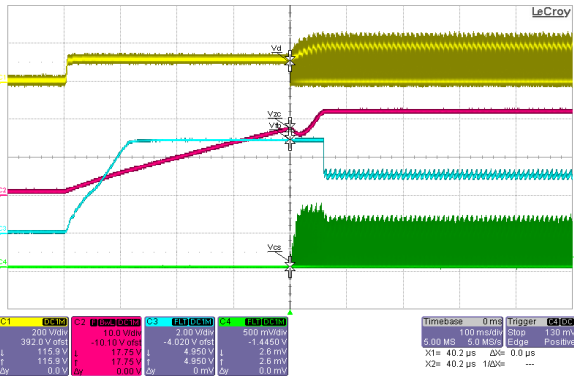

Figure 14 Constant charging VCC during startup

Ch1 Drain source voltage

Ch2 VCC supply voltage

Ch3 Feedback voltage

Ch4 Current sense voltage

Test condition: input 85Vac output 1.75A load

Startup time : 400ms

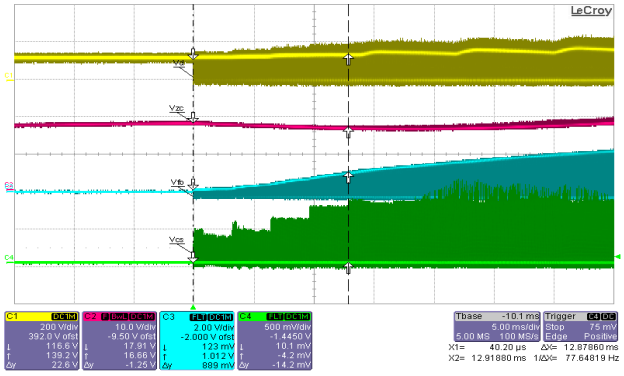

Figure 15 Softstart of current in 4 steps

Ch1 Drain source voltage

Ch2 VCC supply voltage

Ch3 Zero crossing voltage

Ch4 Current sense voltage

Test condition: input 85Vac output 1.75A load

Soft-start time : 12.87ms

12.2 Working at different zero crossing point

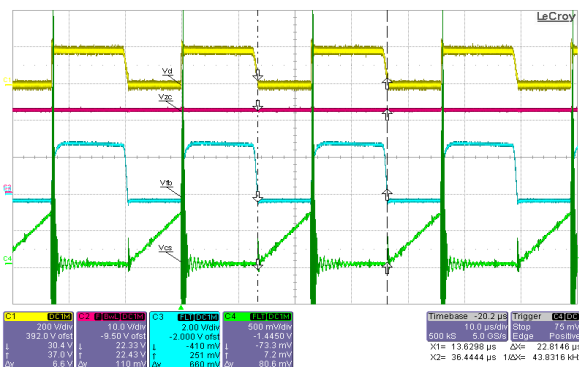

Figure 16 Working at first ZC point

Ch1 Drain source voltage

Ch2 VCC supply voltage

Ch3 Zero crossing voltage

Ch4 Current sense voltage

Test condition: input 85Vac, output 16V/1.75A

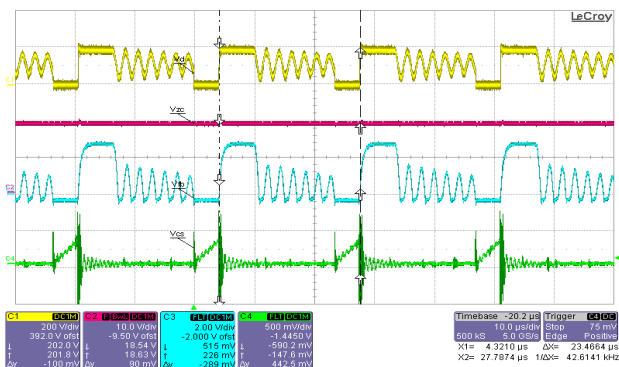

Figure 17 Working at 7th ZC point

Ch1 Drain source voltage

Ch2 VCC supply voltage

Ch3 Zero crossing voltage

Ch4 Current sense voltage

Test condition: input 85Vac, output 16V/0.3A

12.3 Burst mode operation

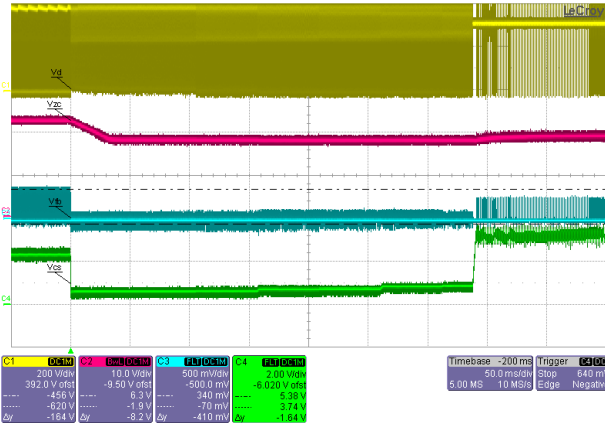

Figure 18 Entering burst mode

Ch1 Drain source voltage
 Ch2 Supply voltage VCC
 Ch3 Current sense voltage
 Ch4 Feedback voltage Vfb

Test condition: load jump from 1.75A to 0.1A at 230Vac line

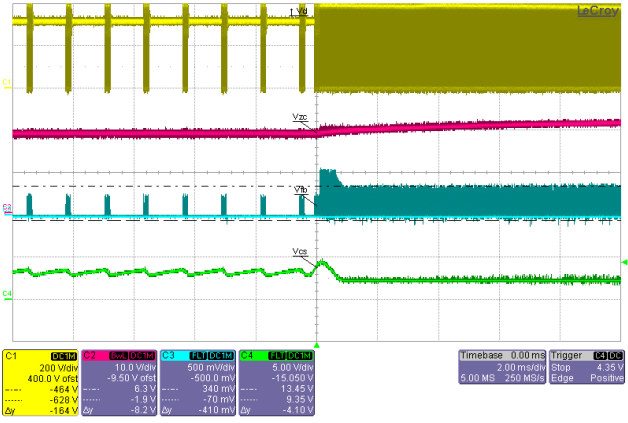

Figure 19 Leaving burst mode

Ch1 Drain source voltage
 Ch2 Supply voltage VCC
 Ch3 Current sense voltage
 Ch4 Feedback voltage Vfb

Test condition: load jump from 0A to 1.75A at 230Vac line

12.4 Protection modes

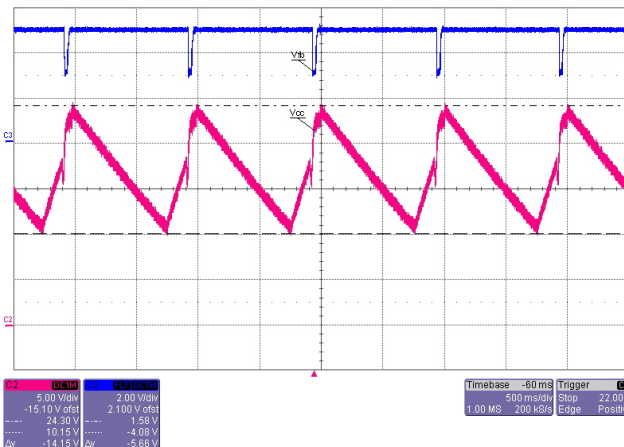

Figure 20 VCC Over-voltage Protection

Ch2 VCC Supply Voltage
 Ch3 Feedback Voltage, VFB

Test Condition: open the zener clamping with overload at high-line

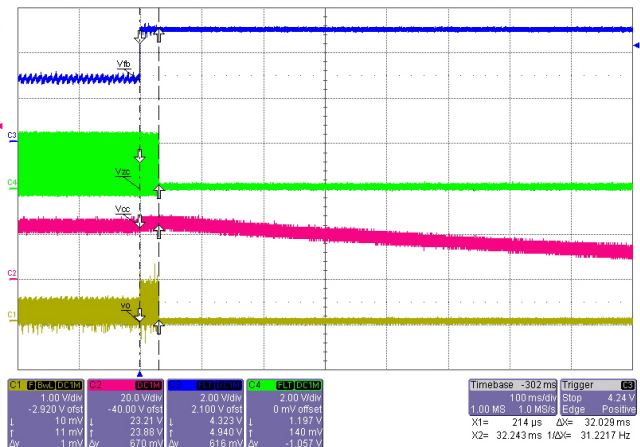

Figure 21 Over Load/ Open Loop Protection

Ch1 Output Voltage, Vo
 Ch2 VCC Supply Voltage
 Ch3 Feedback Voltage, VFB
 Ch4 Zero Crossing Voltage, VZC

Test Condition: Load change from 1A to 5A

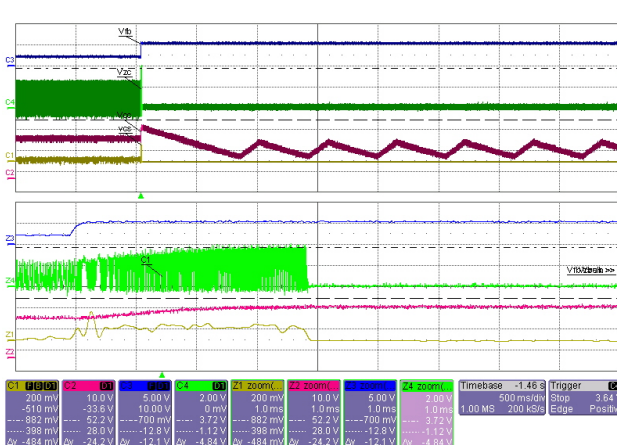

Figure 22 Output Over-voltage Protection

Ch1 Current Sense Voltage, VCS

Ch2 VCC Supply Voltage

Ch3 Feedback Voltage, VFB

Ch4 Zero Crossing Voltage, VZC

Test Condition: change the ZC resistor divider ratio,
Apply 230Vac, Load 1A

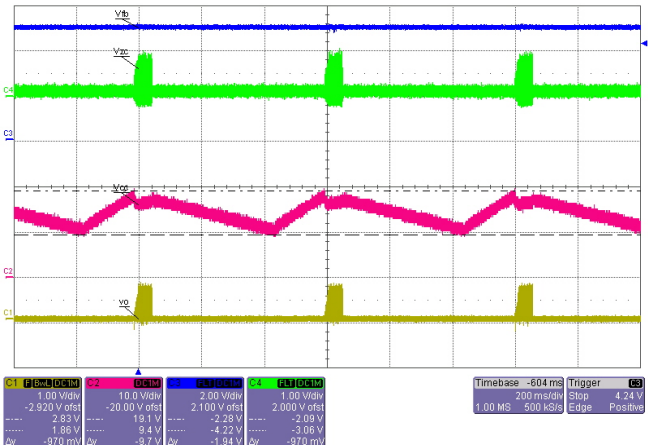

Figure 23 Output Short Circuit Protection

Ch1 Output Voltage, Vo

Ch2 VCC Supply Voltage

Ch3 Feedback Voltage, VFB

Ch4 Zero Crossing Voltage, VZC

Test Condition: Shorted output terminal

13 References

- [1] ICE2QR0665G datasheet, Infineon Technologies AG, 2011
- [2] ICE2Qxx65/80x Quasi Resonance CoolSET Design Guide (ANPS0053), Infineon Technologies AG, 2010
- [3] Design Tips for flyback converters using the Quasi-Resonant (ANPS0005), Infineon Technologies AG, 2006
- [4] Converter Design Using the Quasi-Resonant PWM Controller ICE2QS01 (ANPS0003), Infineon Technologies AG, 2006
- [5] Determine the Switching Frequency of Quasi-Resonant Flyback Converters Designed with ICE2QS01 (ANPS0004), Infineon Technologies AG, 2006