

170 W power supply with PFC and standby supply for flat TV using the L6564, L6599A, and Viper27LN

Introduction

This application note describes the characteristics and features of a 170 W, wide input mains range, power-factor-corrected, demonstration board for flat TVs or industrial applications. The electrical specifications are tailored to a typical flat TV.

The architecture is made up of three stages: a front-end PFC pre-regulator based on the L6564 TM (transition mode) boost PFC controller and a downstream LLC resonant half bridge converter stage, built around the new L6599A resonant controller, which provides two regulated output voltages at 12 V and 24 V. In addition, a flyback-based standby supply delivers 10 W to a 5 V output. Thanks to the chipset used, this design achieves very high efficiency, compliant with ENERGY STAR® eligibility criteria (EPA rev. 2.0 EPS), as well as very low input consumption during standby operation.

Figure 1. EVL170W-FTV: 170 W demonstration board

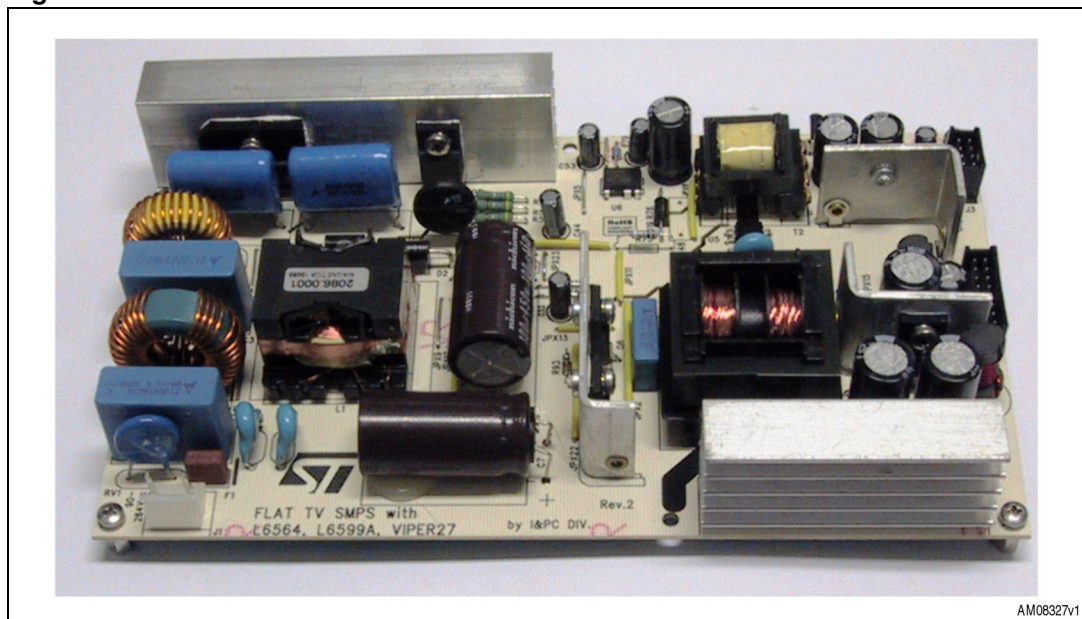

Contents

1	Main characteristics and circuit description	6
2	Efficiency measurement	9
3	Harmonic content measurement	11
4	Functional check	13
5	Conducted emission pre-compliance test	29
6	Bill of materials	31
7	PFC coil specifications	39
8	Resonant power transformer specifications	41
9	Auxiliary flyback transformer specifications	43
10	Revision history	46

List of tables

Table 1.	Overall efficiency measured at different AC input voltages	9
Table 2.	Bill of materials	31
Table 3.	PFC coil winding data	39
Table 4.	Resonant transformer winding data	41
Table 5.	DC output voltage and load	43
Table 6.	Standby transformer winding data	44
Table 7.	Document revision history	46

List of figures

Figure 1.	EVL170W-FTV: 170 W demonstration board	1
Figure 2.	Electrical diagram	8
Figure 3.	Overall efficiency vs. output power	10
Figure 4.	Average efficiency acc. ES-2	10
Figure 5.	Standby supply efficiency vs. output power	10
Figure 6.	Standby supply efficiency vs. light load output power	10
Figure 7.	EN61000-3-2 compliance at 230 Vac - 50 Hz, full load	11
Figure 8.	JEITA-MITI compliance at 100 Vac - 50 Hz, full load	11
Figure 9.	EN61000-3-2 compliance at 230 Vac - 50 Hz, 75 W	11
Figure 10.	JEITA-MITI compliance at 100 Vac - 50 Hz, 75 W	11
Figure 11.	Input voltage and current at 100 Vac, full load	12
Figure 12.	Input voltage and current at 230 Vac, full load	12
Figure 13.	Standby supply waveforms at 115 Vac - 60 Hz, full load	13
Figure 14.	Standby supply waveforms at 230 Vac - 50 Hz, full load	13
Figure 15.	Standby supply waveforms at 400 Vdc, full load	14
Figure 16.	Standby supply output rectifiers PIV at 400 Vdc, full load	14
Figure 17.	Standby supply 5 V ripple at 115 Vac - 60 Hz, full load	14
Figure 18.	Standby supply startup at 115 Vac - 60 Hz, full load	14
Figure 19.	Standby supply burst mode operation at 230 Vac - 50 Hz - 10 mA load	15
Figure 20.	Standby supply burst mode operation at 230 Vac - 50 Hz - 10 mA load-detail	15
Figure 21.	Standby supply OVP at 115 Vac - 60 Hz, full load	15
Figure 22.	Standby supply OVP at 230 Vac - 50 Hz - 0.5 A	15
Figure 23.	Standby supply OVP at 115 Vac - 60 Hz - PFC on - 1 A	16
Figure 24.	Standby supply OVP at 115 Vac - 60 Hz - PFC on - 1 A	16
Figure 25.	Standby supply output short-circuit at 230 Vac - 50 Hz, full load	16
Figure 26.	Standby supply output short-circuit at 230 Vac - 50 Hz, full load - detail	16
Figure 27.	Standby supply dynamic load at 115 Vac - 60 Hz - PFC off	17
Figure 28.	Standby supply dynamic load at 115 Vac - 60 Hz - PFC on	17
Figure 29.	PFC Vds and inductor current at 115 Vac - 60 Hz, full load	18
Figure 30.	PFC Vds and inductor current at 115 Vac - 60 Hz, full load - detail	18
Figure 31.	PFC Vds and inductor current at 230 Vac - 50 Hz, full load	19
Figure 32.	PFC Vds and inductor current at 230 Vac - 50 Hz, full load - detail	19
Figure 33.	L6564 signals-1 at 115 Vac - 60 Hz, full load	19
Figure 34.	L6564 signals-2 at 115 Vac - 60 Hz, full load	19
Figure 35.	PFC signals-1 at 115 Vac - 60 Hz, full load	20
Figure 36.	PFC signals-2 at 115 Vac - 60 Hz, full load	20
Figure 37.	Resonant stage waveforms at 115 V - 60 Hz, full load	21
Figure 38.	Resonant stage waveforms at 115 V - 60 Hz, full load	21
Figure 39.	Output rectifiers PIV waveforms	22
Figure 40.	No load operation at 115 Vac - 60 Hz	22
Figure 41.	No load operation at 115 Vac - 60 Hz - L6599A signals	22
Figure 42.	12 V - 2 A; 24 V 0 ÷ 6 A transition at 115 Vac - 60 Hz	23
Figure 43.	24 V - 6 A; 12 V 0 ÷ 2 A transition at 115 Vac - 60 Hz	23
Figure 44.	12 V - 2 A; 24 V 0 ÷ 6 A - 300 Hz transition at 115 Vac - 60 Hz	24
Figure 45.	24 V - 6 A; 12 V 1 ÷ 2 A - 300 Hz transition at 115 Vac - 60 Hz	24
Figure 46.	12 V short-circuit at full load and 115 Vac - 60 Hz	25
Figure 47.	12 V short-circuit at full load and 115 Vac - 60 Hz - detail	25
Figure 48.	24 V short-circuit at full load and 115 Vac - 60 Hz	25
Figure 49.	24 V short-circuit at full load and 115 Vac - 60 Hz - detail	25

Figure 50.	Startup by on-off signal at full load and 115 Vac - 60 Hz	26
Figure 51.	Startup by on-off signal at full load and 115 Vac - 60 Hz - L6599A signals	26
Figure 52.	Startup by on/off signal at full load and 115 Vac - 60 Hz O/P voltage rising	27
Figure 53.	Turn-off at full load and 115 Vac - 60 Hz by on/off signal	27
Figure 54.	OVP at full load and 115 Vac - 60 Hz on 12 V - 24 V	27
Figure 55.	OVP at full load and 115 Vac - 60 Hz on 12 V - 24 V - outputs detail	27
Figure 56.	Half cycle mains dip at full load and 115 Vac - 60 Hz	28
Figure 57.	Full cycle mains dip at full load and 115 Vac - 60 Hz	28
Figure 58.	CE peak measurement at 115 V - 60 Hz and full load - phase wire	29
Figure 59.	CE peak measurement at 115 V - 60 Hz and full load - neutral wire	29
Figure 60.	CE peak measurement at 230 V - 50 Hz and full load - phase wire	30
Figure 61.	CE peak measurement at 230 V - 50 Hz and full load - neutral wire	30
Figure 62.	PFC coil electrical diagram	39
Figure 63.	PFC coil mechanical aspect	40
Figure 64.	Transformer overall drawing	41
Figure 65.	Transformer electrical diagram	42
Figure 66.	Transformer construction	44
Figure 67.	Mechanical aspect and pin numbering	44
Figure 68.	Mechanical aspect and pin numbering	45

1 Main characteristics and circuit description

The main features of the SMPS are:

- Universal input mains range: $90 \div 264 \text{ Vac}$ - frequency $45 \div 65 \text{ Hz}$
- Output voltage 1: $24 \text{ V} \pm 5 \%$ at 6 A for backlight and audio supply
- Output voltage 2: $12 \text{ V} \pm 3 \%$ at 2 A for TV panel supply
- Output voltage 3: $5 \text{ V} \pm 2 \%$ at 2 A for microprocessor supply
- Mains harmonics: acc. to EN61000-3-2 Class-D or JEITA-MITI Class-D
- Standby mains consumption: at 230 Vac <150 mW with 50 mW load
- Overall efficiency at full load: above 90 %
- EMI: according to EN55022-Class-B
- Safety: according to EN60065
- Dimensions: 197x115 mm, 25 mm maximum component height from PCB
- PCB: single side, 70 μm , CEM-1, mixed PTH/SMT.

The circuit is made up of two sections; a 10 W supply generating 5 V standby output, dedicated to supplying the TV microprocessor and the logic circuitry, and a larger section made up of a PFC front-end and an LLC resonant converter which provides two output voltages, one dedicated to supplying the TV panel, and one for the backlight and audio power amplifiers. The PFC stage delivers 400 V constant voltage and acts as a pre-regulator for both the LLC stage and the standby supply. An external signal, referred to as secondary ground, turns the PFC and LLC stages on and off.

Startup

At turn-on the standby supply starts up and delivers 5 V dedicated to the TV microprocessor and other logic circuitry. It also generates the auxiliary supply voltage for the PFC and LLC controllers at primary side via the linear regulator Q7. Q7 is activated by the optocoupler U5, that is driven by the logic signal on/off (active high). At startup, the on/off signal (delivered by the microprocessor) is supposed to be low, so the PFC and the LLC are off. Once the on/off signal is asserted high, the regulator Q7 provides 14 V to the L6564 PFC controller and the L6599A LLC controller; to always ensure proper operation of the LLC, the circuit is designed so that the PFC starts first, then the downstream converter. The LINE pin of L6599A allows the resonant stage to operate only if the PFC output is delivering its rated output voltage. It prevents the resonant converter from working with an input voltage that is too low which may cause the undesirable capacitive-mode operation. The L6599A LINE pin internal comparator has a hysteresis allowing to set the turn-on and turn-off thresholds independently. The LLC turn-on voltage (PFC output) and the turn-off threshold are set to 380 V and 300 V respectively. This last value prevents the LLC stage operating in capacitive-mode but allows the resonant stage to operate even in the case of mains sag or dips lowering the PFC output voltage.

Brownout protection

Brownout protection prevents the circuit from working with abnormal mains levels. It is accomplished by both the Viper, through the brownout pin, and the L6564, through an internal comparator internally connected to the VFF pin (#5), which detects the mains voltage peak value. The internal comparators allow the IC operation with proper mains level only, as defined by power supply specifications, therefore, if the input voltage is below around 80 Vac (typ.), the circuit is not allowed to start up.

Resonant power stage

The downstream converter features the ST L6599A, which embeds all the functions needed to drive properly the resonant converter with 50 % fixed duty cycle and variable frequency. The converter makes use of a transformer designed with the integrated magnetic approach, using the primary leakage as the resonant series inductance and the magnetizing inductance as the resonant shunt inductance. The transformer secondary-side is center-tapped and power Schottky diodes are used as output rectifiers. Additional LC filter stages have been added on each output to minimize high-frequency ripple.

Output voltage feedback loop

The regulation feedback loop is implemented through a typical circuit using a TL431, which modulates the current through the optocoupler diode. In order to improve the cross regulation, the two resonant stage output voltages are regulated by a weighted feedback control, that is using a single rail to regulate multiple outputs. The feedback loop is closed to the primary side by R37, which connects the RFMIN (#4) pin of the resonant controller L6599A to the optocoupler phototransistor and sets the maximum switching frequency at around 130 kHz. This value has been chosen to limit the switching losses at light load operation. On the same pin, R36 connected to ground, sets the minimum switching frequency. The RC series R22 and C21 sets both soft-start maximum frequency as well as duration.

L6599A overload and short-circuit protection

Half bridge primary-side current is sensed by the lossless circuit consisting of R53, C36, D14, D12, R55, and C38 and is fed into the ISEN pin (#6). During an overcurrent event, the pin voltage rises to the internal comparator threshold (0.8 V), triggering the following protection sequence: the soft-start capacitor (C10) connected to the DELAY pin (#2) is charged by an internal 150 μ A current generator and is slowly discharged by the resistor R12. This pin is connected to the DIS (#8) pin and, if the voltage reaches 1.85 V, the IC stops switching, being latched off. Once latched, an on/off signal recycle is needed to restart the converter.

Overvoltage and open loop protection

Both PFC and resonant stages are provided with their own overvoltage protections. The PFC controller L6564 monitors its output voltage through the resistor divider connected to the PFC_OK pin (#6) protecting the circuit in case of loop failure, disconnection, or deviation from the nominal value of the feedback loop divider. When a fault condition is detected, the L6564 is shut down and latched off by an internal circuit monitoring the voltage on the PFC_OK and INV pins, until the mains voltage is recycled. Upon the occurrence of an overvoltage condition, of either the 24 V or 12 V output of the resonant stage, the Zener diodes D16 and D17 conduct, respectively, forcing Q10 to be turned on by the resulting base current, which causes Q9 to conduct. These two transistors form a pnp-npn SCR (silicon controlled rectifier) structure that shorts to ground the anode of the U5 optocoupler in such a way that the IC supply voltage V_{cc} cannot be delivered to controllers by Q7, forcing them to be latched off until the mains voltage is recycled.

Figure 2. Electrical diagram

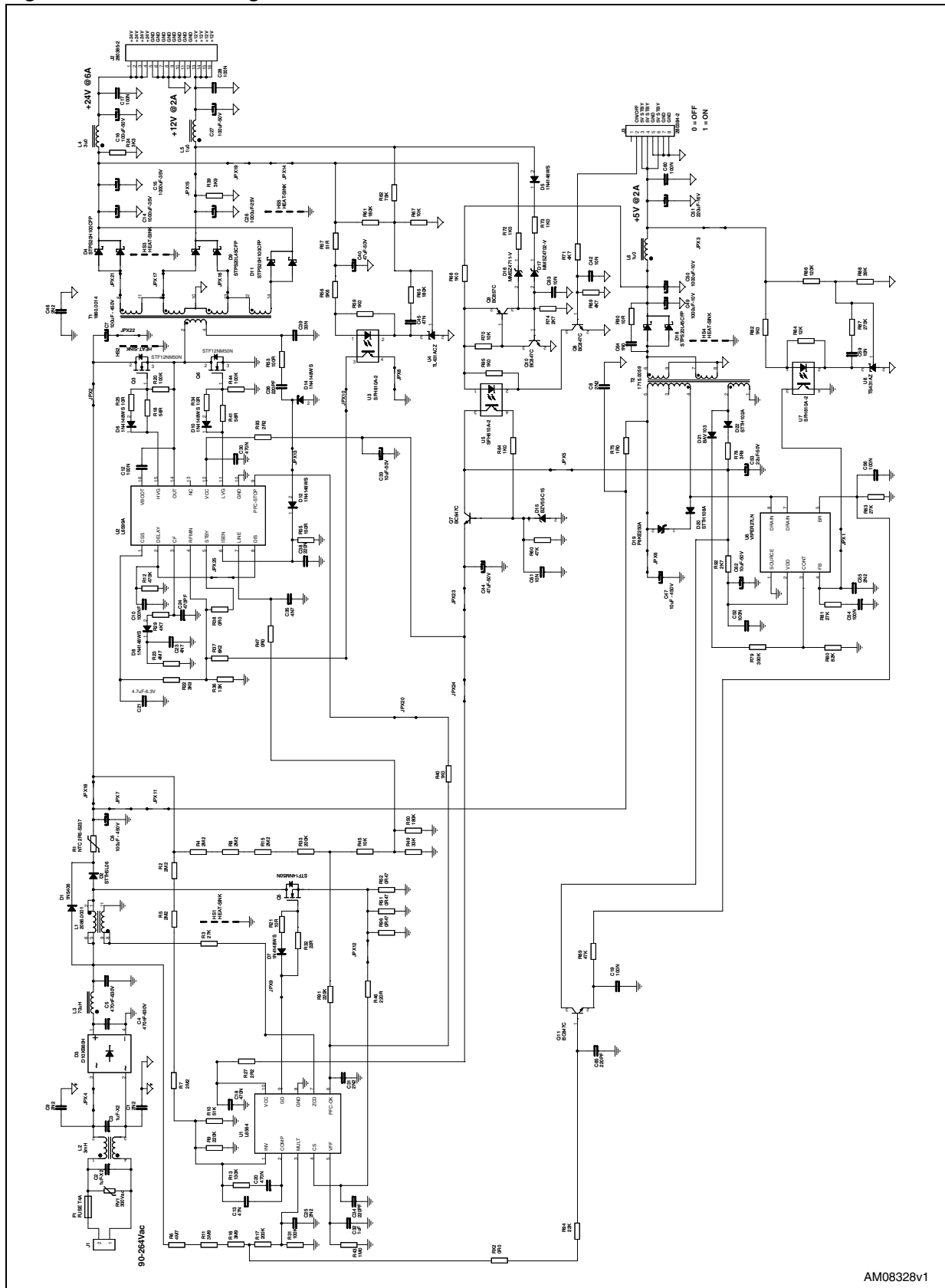

2 Efficiency measurement

Table 1 shows the overall efficiency, measured at different mains voltages. The full load efficiency is 90.09 % at 115 Vac, and 91.85 % at 230 Vac. Both values are considerably high and maintained high even decreasing the load as reported in *Table 1*. Measurements are also reported in the graph of *Figure 3*.

Table 1. Overall efficiency measured at different AC input voltages

Load = 100 %									
5 V		12 V		24 V		Pout	Pin	Eff.	
Vin [Vrms]	Vout [V]	Iout [A]	Vout [V]	Iout [A]	Vout [V]	Iout [A]	[W]	[W]	[%]
90	5.01	1.99	11.69	2.01	23.47	5.98	173.8	197.5	88.00 %
115	5.01	1.99	11.69	2.01	23.48	5.98	173.9	193.6	90.09 %
230	5.01	1.99	11.69	2.01	23.48	5.98	173.8	189.3	91.85 %
265	5.01	1.99	11.69	2.01	23.48	5.98	173.8	188.9	91.98 %
Load = 75 %									
5 V		12 V		24 V		Pout	Pin	Eff.	
Vin [Vrms]	Vout [V]	Iout [A]	Vout [V]	Iout [A]	Vout [V]	Iout [A]	[W]	[W]	[%]
90	5.01	1.51	11.70	1.51	23.49	4.50	130.9	147.5	88.78 %
115	5.01	1.51	11.70	1.51	23.49	4.50	130.9	145.5	89.96 %
230	5.01	1.51	11.70	1.51	23.49	4.50	130.9	143.0	91.56 %
265	5.01	1.51	11.70	1.51	23.49	4.50	130.9	142.7	91.73 %
Load = 50 %									
5 V		12 V		24 V		Pout	Pin	Eff.	
Vin [Vrms]	Vout [V]	Iout [A]	Vout [V]	Iout [A]	Vout [V]	Iout [A]	[W]	[W]	[%]
90	5.01	1.00	11.71	1.01	23.51	3.00	87.5	98.6	88.67 %
115	5.01	1.00	11.72	1.01	23.51	3.00	87.5	97.7	89.54 %
230	5.01	1.00	11.71	1.01	23.51	3.00	87.5	96.6	90.53 %
265	5.01	1.00	11.71	1.01	23.51	3.00	87.5	96.5	90.64 %
Load = 25 %									
5 V		12 V		24 V		Pout	Pin	Eff.	
Vin [Vrms]	Vout [V]	Iout [A]	Vout [V]	Iout [A]	Vout [V]	Iout [A]	[W]	[W]	[%]
90	5.02	0.49	11.72	0.50	23.53	1.51	43.83	50.82	86.25 %
115	5.02	0.49	11.72	0.50	23.53	1.51	43.83	50.57	86.67 %
230	5.02	0.49	11.72	0.50	23.53	1.51	43.83	50.47	86.85 %
265	5.02	0.49	11.72	0.50	23.53	1.51	43.83	50.29	87.16 %

The average efficiency has been calculated according to ENERGY STAR 2.0 criteria. Results are summarized in [Figure 3](#) and [4](#).

Figure 3. Overall efficiency vs. output power **Figure 4. Average efficiency acc. ES-2**

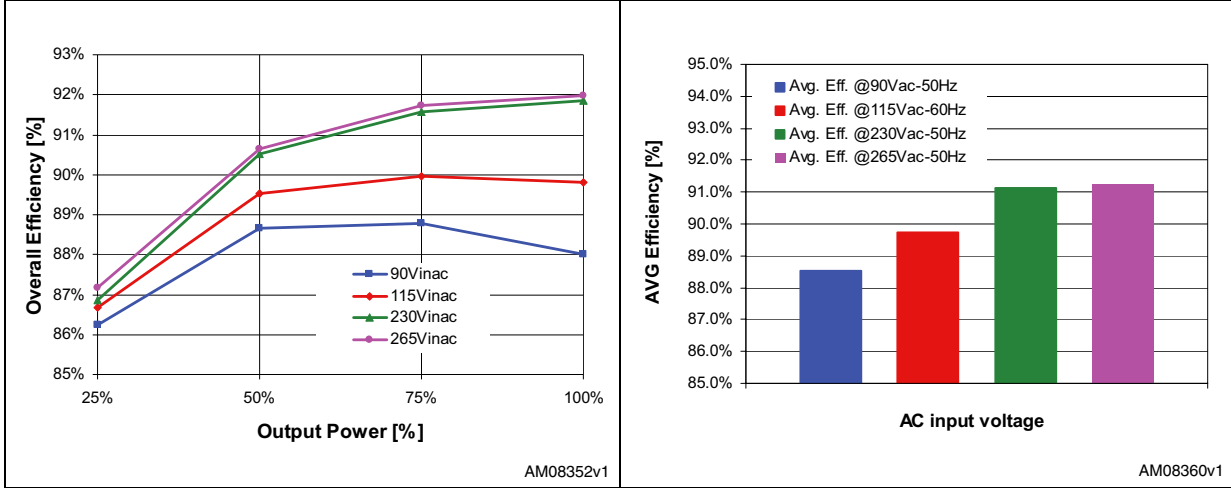

Standby supply efficiency

Standby supply efficiency has been measured and the results are plotted in [Figure 5](#). As shown, the efficiency during rated load operation is above 82 %, over the whole input mains voltage range, from 50 % to full load.

Efficiency during standby operation at very light load, like microprocessor and wake-up circuitry, is plotted in [Figure 6](#). As shown, in this condition it is higher than 35 % at 230 Vac, therefore, it allows to supply the microprocessor with a significant low consumption from the mains. It should be mentioned that the standby supply efficiency has been calculated measuring the input power at the input connector, including power loss contribution due to all residual loads connected to mains before and after the input bridge rectifier, like the EMI filter and PFC resistor dividers.

Figure 5. Standby supply efficiency vs. output power

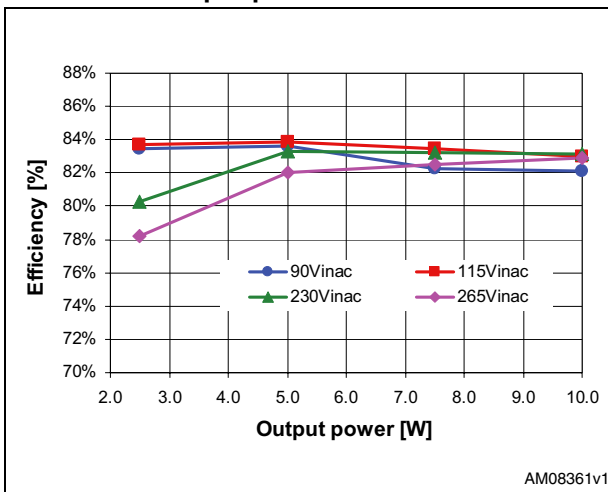
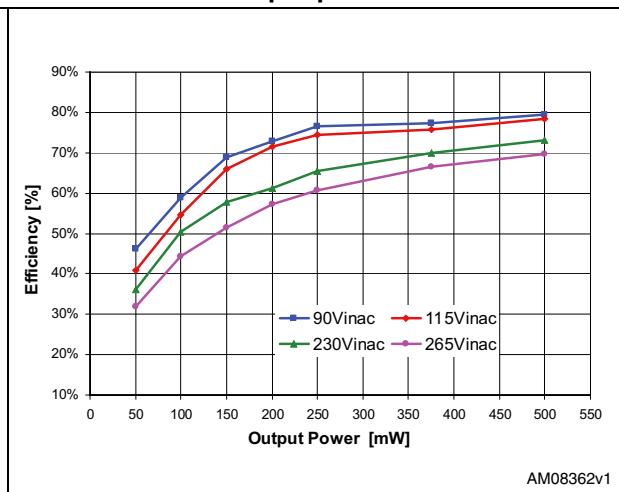

Figure 6. Standby supply efficiency vs. light load output power



3 Harmonic content measurement

The main purpose of a PFC pre-regulator is the input current shaping to reduce the harmonic content below the limits of the relevant regulations. This demonstration board has been tested according to the European standard EN61000-3-2 Class-D and Japanese standard JEITA-MITI Class-D, at full load and 75 W input power, at both the nominal input voltage mains. *Figure 7* to *Figure 10* show the test results. Note that the PFC stage operates properly as it effectively reduces harmonics well below the limits of both regulations in all conditions. Total harmonic distortion and power factor values are reported below in each diagram.

Figure 7. EN61000-3-2 compliance at 230 Vac - 50 Hz, full load

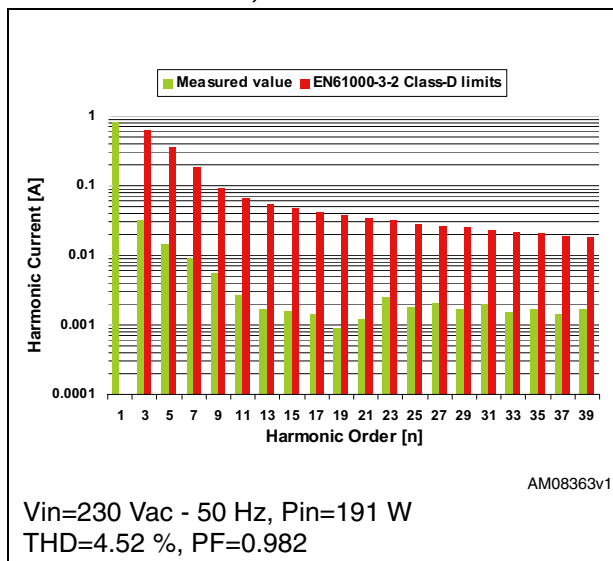

Figure 8. JEITA-MITI compliance at 100 Vac - 50 Hz, full load

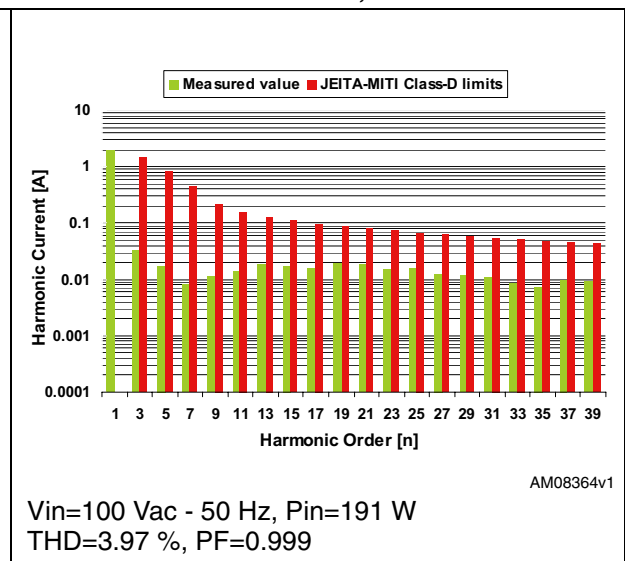

Figure 9. EN61000-3-2 compliance at 230 Vac - 50 Hz, 75 W

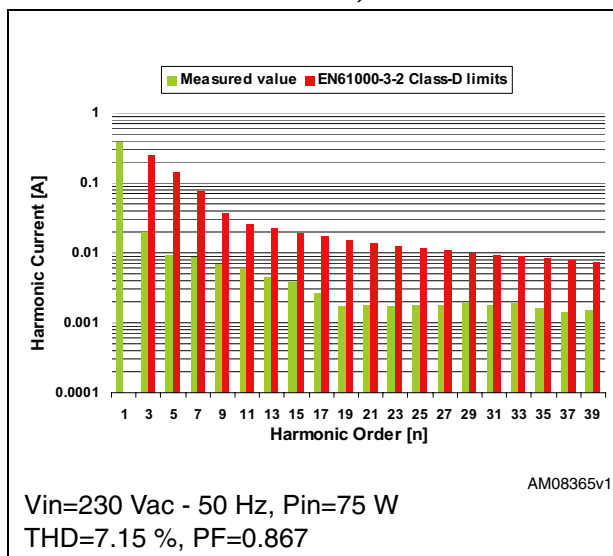
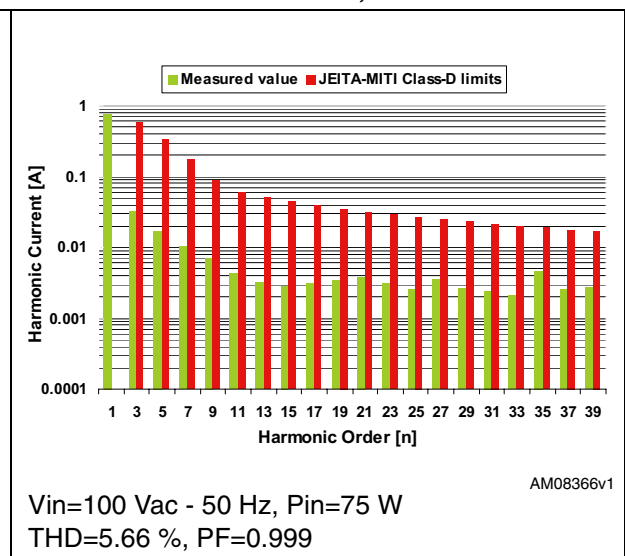

Figure 10. JEITA-MITI compliance at 100 Vac - 50 Hz, 75 W



In [Figure 11](#) and [12](#) the AC input voltage and current waveform at nominal input mains and full load are reported for reference.

Figure 11. Input voltage and current at 100 Vac, full load

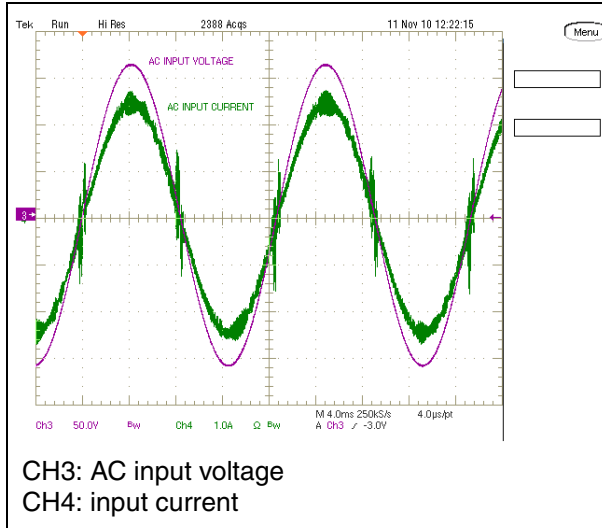
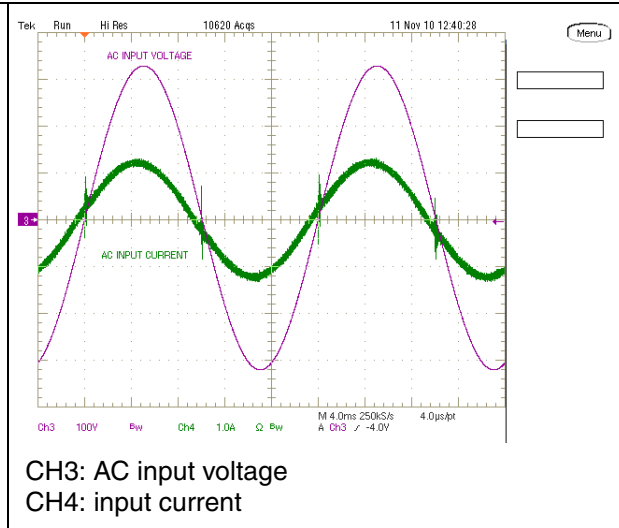

Figure 12. Input voltage and current at 230 Vac, full load



4 Functional check

Standby supply

Some salient waveforms of the standby supply during full load operation are reported in [Figure 13](#) and [Figure 14](#). This converter is based on the Viper27LN, a device integrating the controller and the MOSFET in a single DIP-7 package. The Viper27LN version operates in fixed frequency mode at about 60 kHz, and frequency jitter technique is implemented to reduce EMI noise. In order to obtain good efficiency as well as reduced transformer size the converter has been designed to operate at full load in continuous conduction mode at low mains voltage ([Figure 13](#)) and discontinuous conduction mode at high mains voltage ([Figure 14](#)), once the PFC and resonant stages are off. It can be noted from the drain waveforms that the typical ringing at turn-off is limited, thanks to the small value of the transformer's primary leakage inductance, allowing limited power dissipation on the Transil diode D19 and therefore enhancing the efficiency at rated load. D19 acts as a clamper and allows to limit the drain peak voltage below the Viper27LN maximum rating even with maximum input voltage and full load operation.

Figure 13. Standby supply waveforms at 115 Vac - 60 Hz, full load

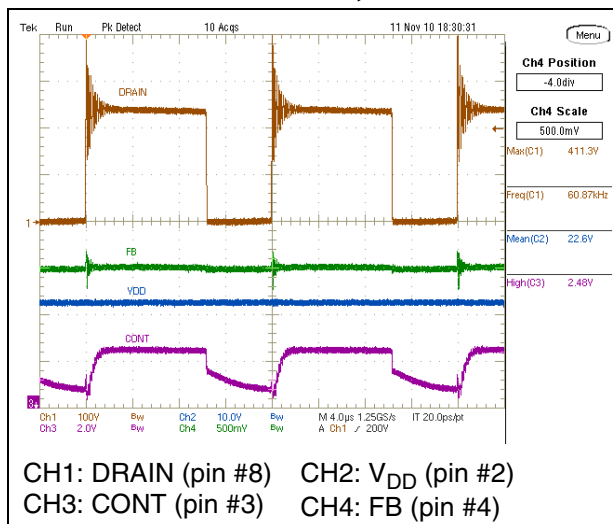
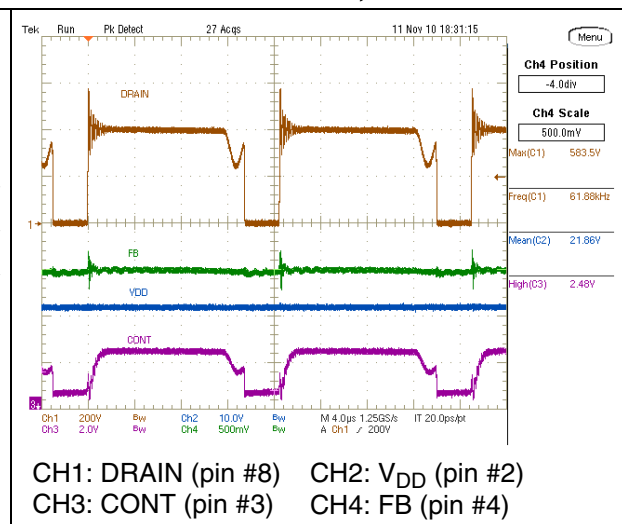

Figure 14. Standby supply waveforms at 230 Vac - 50 Hz, full load



In [Figure 15](#) the converter waveforms are captured while the PFC is working and the standby supply is powered with 400 V. The margin with respect to the Viper27LN maximum drain voltage can be noted on the sidebar on the right.

In [Figure 16](#) typical waveforms relevant to the secondary side have been captured; the maximum reverse voltages applied to the rectifier at 400 V during full load operation with PFC working are, even in this case, well below the component's maximum ratings, ensuring long term reliability.

Figure 15. Standby supply waveforms at 400 Vdc, full load

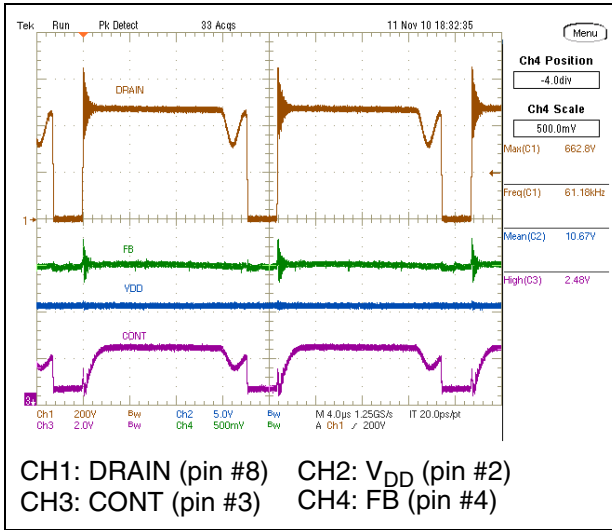
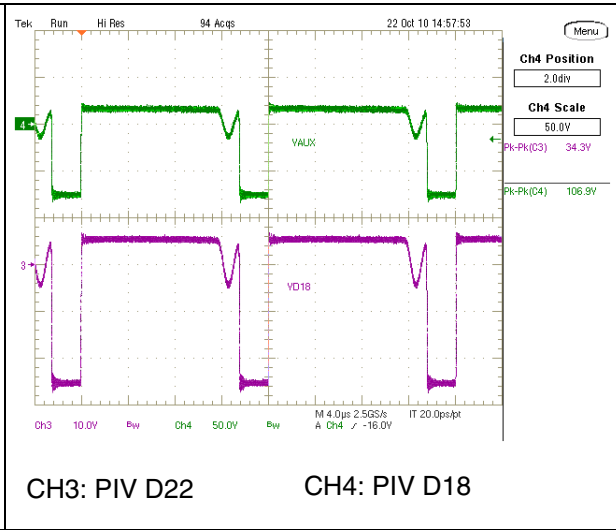

Figure 16. Standby supply output rectifiers PIV at 400 Vdc, full load



In *Figure 17* the 5 V standby output voltage ripple has been captured during operation at 115 Vac of the standby converter only. Ripple and noise measured at full load are very limited.

Figure 18 shows the waveforms during the startup of the standby converter only, at 115 Vac and full load. At Viper27LN power-on the V_{cc} capacitor is charged by the internal startup current source until its voltage reaches the turn-on threshold. At this point the Viper27LN starts operating and the output voltage rises to reach the nominal value. During the converter startup, the Viper27LN internal digital fixed time-based (8.5 ms) soft-start gradually increases the drain current to its maximum value. In this way the stress on the secondary diode is considerably reduced and transformer saturation is prevented. The brownout circuit prevents the Viper27LN from starting up during abnormal mains conditions.

Figure 17. Standby supply 5 V ripple at 115 Vac - 60 Hz, full load

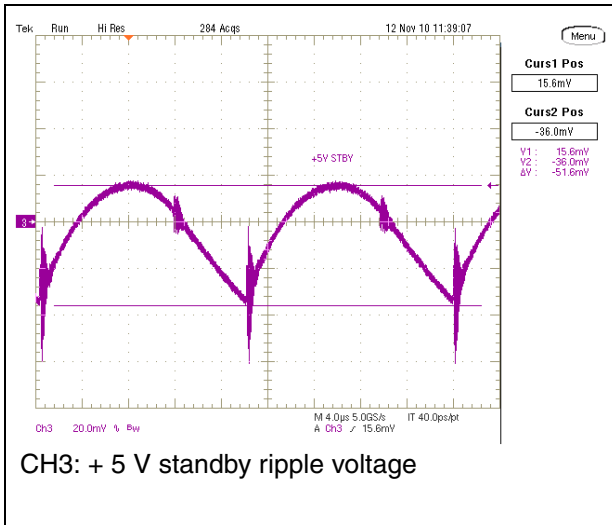

Figure 18. Standby supply startup at 115 Vac - 60 Hz, full load

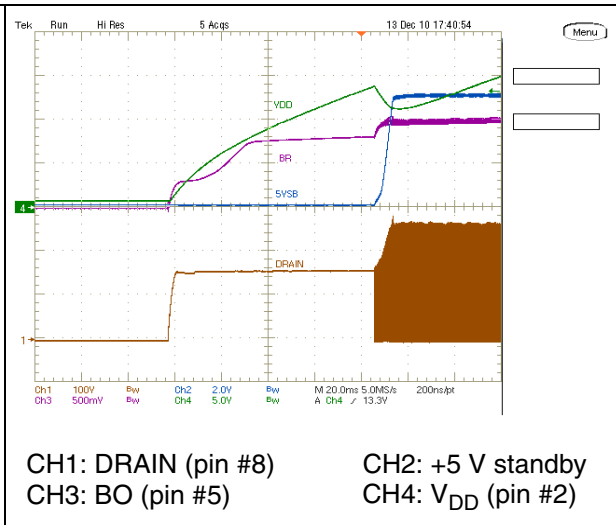

Figure 19 and Figure 20 illustrate the waveforms during light load operation. Viper27LN operates in burst-mode, with just a few pulses per burst, minimizing switching losses and therefore improving efficiency under light load operation, making it suitable for equipment with low standby consumption requirements.

Figure 19. Standby supply burst mode operation at 230 Vac - 50 Hz - 10 mA load

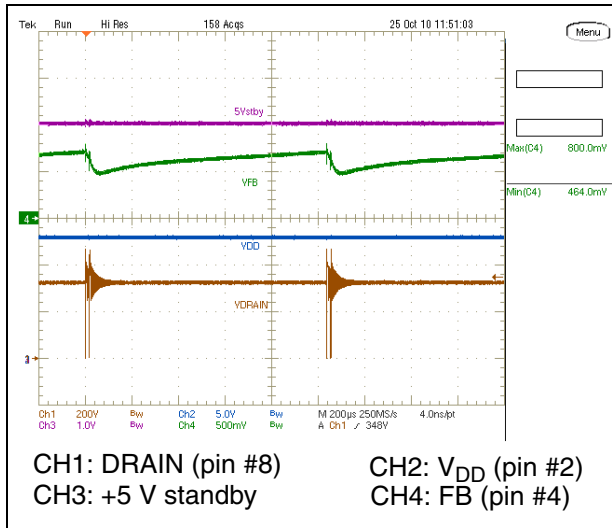

Figure 20. Standby supply burst mode operation at 230 Vac - 50 Hz - 10 mA load-detail

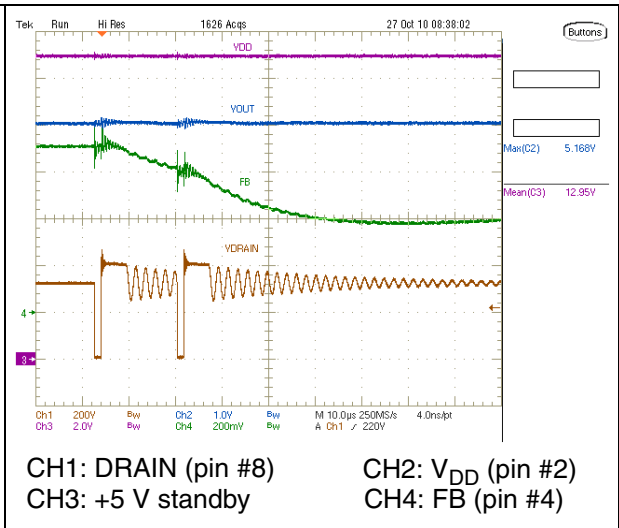

Figure 21. Standby supply OVP at 115 Vac - 60 Hz, full load

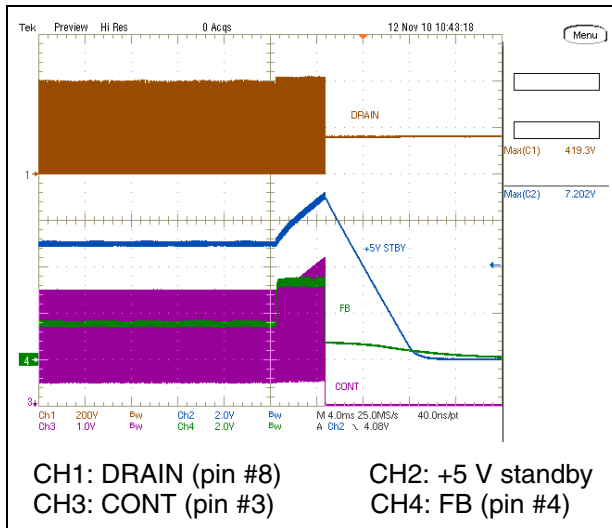

Figure 22. Standby supply OVP at 230 Vac - 50 Hz - 0.5 A

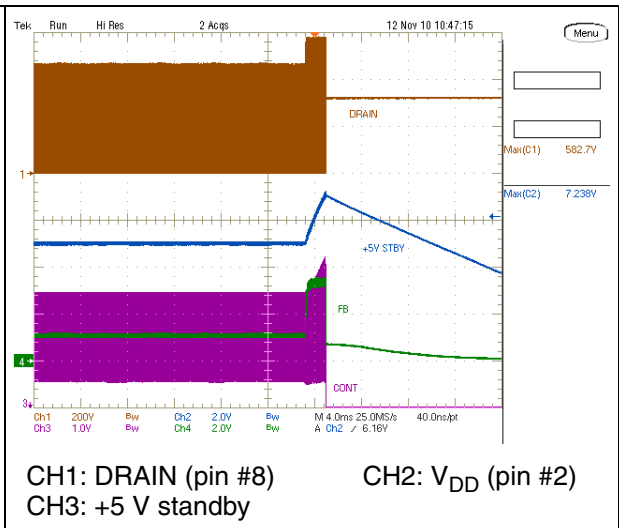

Figure 21 shows the OVP response, observed opening the Viper27LN feedback loop. If the output voltage value exceeds the internal threshold set by the resistor divider connected to the CONT pin (#3), the Viper27LN stops working, providing protection against dangerous voltages which may damage the system. It remains latched until the V_{DD} has dropped down to V_{DD_RESTART} (4.5 V). At this point the auto-restart process takes place like any startup; the internal current source charges the V_{DD} capacitor until it reaches the V_{DDon} threshold

and switching starts again. This protection and restart sequence lasts as long as the OVP condition is removed. It is important to highlight that the Viper27LN OVP protection, thanks to the internal logic, ensures a stable OVP intervention point, independent of the output load, even if the voltage sensing is done on auxiliary winding at primary side. It can be noted, by comparing [Figure 21](#) to [Figure 23](#) which report some OVP intervention with different loads and input voltage conditions, that the maximum output voltage peak has a negligible variation.

Figure 23. Standby supply OVP at 115 Vac - 60 Hz - PFC on - 1 A

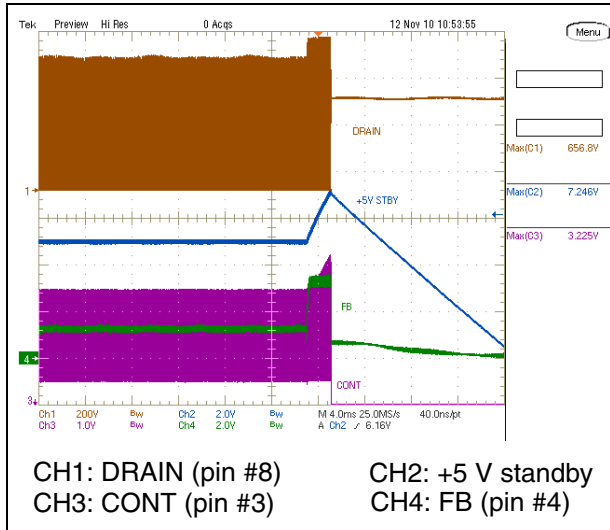

Figure 24. Standby supply OVP at 115 Vac - 60 Hz - PFC on - 1 A

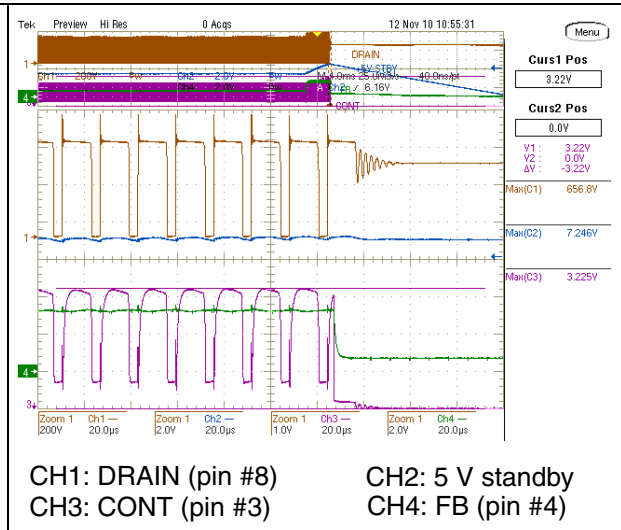

Figure 25. Standby supply output short-circuit at 230 Vac - 50 Hz, full load

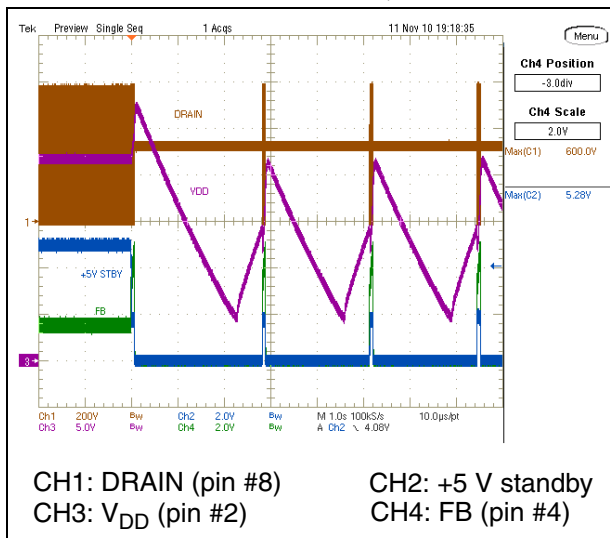
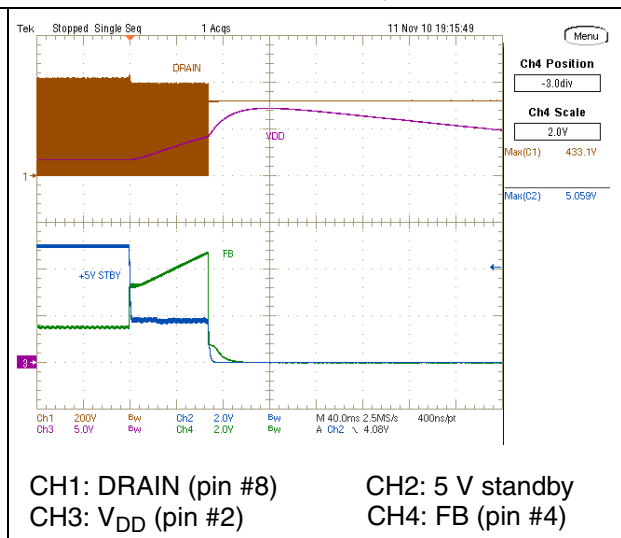

Figure 26. Standby supply output short-circuit at 230 Vac - 50 Hz, full load - detail



[Figure 24](#) shows, in detail, the OVP intervention at 115 Vac. In [Figure 25](#) a short-circuit event on the standby supply output has been captured. In this situation the Viper27LN enters a safe hiccup mode, providing protection against overheating of the auxiliary converter power components.

In [Figure 26](#) details of Viper27LN operation at short detection is captured; once an output short-circuit is detected, an internal current source charges the device internal circuitry and stops the auxiliary converter operation until the V_{DD} voltage drops down to $V_{DD_RESTART}$ (4.5 V). At that time the internal HV current source is activated and charges the V_{DD} capacitor until it reaches the V_{DDon} threshold, then the Viper27LN restarts switching via a soft-start cycle. Hiccup cycles are repeated as long as the short-circuit condition lasts. Viper27LN is resumed back to normal operation only when the short-circuit condition is removed.

[Figure 27](#) and [28](#) show the load regulation for the 5 V standby output. The standby supply has been tested in the most critical situation, the transition from full load to no load and vice versa. In fact, when a flyback converter is operating at full load, typically the self supply voltage V_{DD} spike is quite high, due to the effect of the leakage inductance. Once the load is decreased or removed, V_{DD} tends to reduce. Since the circuit works in burst-mode during no load operation, at high mains the burst pulses have a low repetition rate due to the almost negligible residual load. In this condition the V_{DD} might drop below $V_{DD_RESTART}$ (4.5 V), causing the auto-restart cycles activation by the controller and consequent reset by the microprocessor powered by the 5 V standby. As can be seen in [Figure 27](#) and [28](#), both transitions are clean and there is no output voltage or Vcc dip.

Figure 27. Standby supply dynamic load at 115 Vac - 60 Hz - PFC off

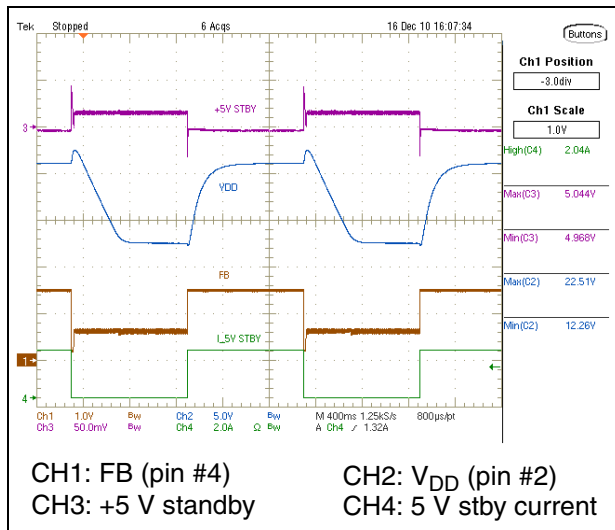
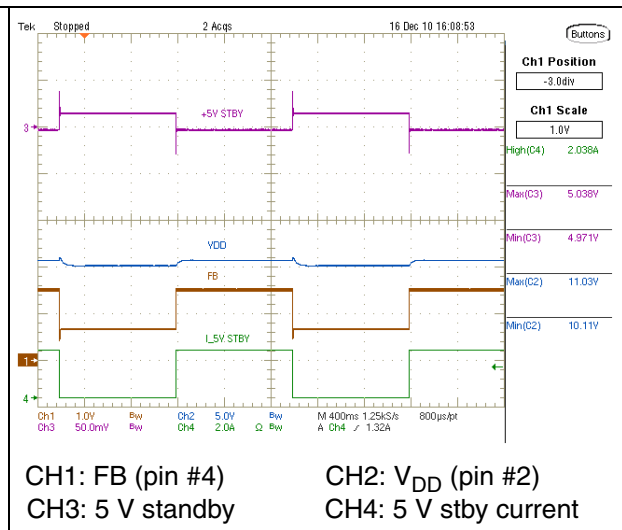

Figure 28. Standby supply dynamic load at 115 Vac - 60 Hz - PFC on



Power factor corrector stage

Figure 29 shows the PFC MOSFET's drain voltage, inductor current, and voltages on the CS (#4) and MULT (#3) pins along a line half-period at 115Vac. Low current distortion and high power factor are achieved as the peak inductor current waveform follows the MULT pin. THD (total harmonic distortion) is considerably reduced by the L6564 THD optimizer.

In Figure 30 the same signals are captured at the top of the input sine wave. Transition mode control makes the inductor work on the boundary between continuous and discontinuous conduction mode. When the PFC MOSFET turns on, the inductor current ramps up, until the voltage on the current sense input reaches the reference level programmed by the internal multiplier block. At that point, the PWM comparator changes state, turning off the power switch. During the MOSFET off-time, the current ramps down until it reaches zero, so the inductor is demagnetized. The zero current detection (ZCD) circuit detects that point by monitoring the voltage across the inductor auxiliary winding, which falls to zero when the current reaches zero, due to the resonance between the inductor and the drain capacitance. Once the demagnetization point is detected by the L6564 internal logic, the signal on ZCD drives the MOSFET on again and another switching cycle begins. A significant advantage of TM operation is the possibility to work in ZVS: if the instantaneous input voltage of the converter is lower than the inductor voltage, the ZVS (zero voltage switching) condition is achieved, decreasing MOSFET commutation losses. However, if the instantaneous input voltage is higher than the inductor voltage the MOSFET is turned on at the minimum voltage, on the valley point of the resonance, still minimizing the transition losses, as seen in Figure 32.

Figure 29. PFC Vds and inductor current at 115 Vac - 60 Hz, full load

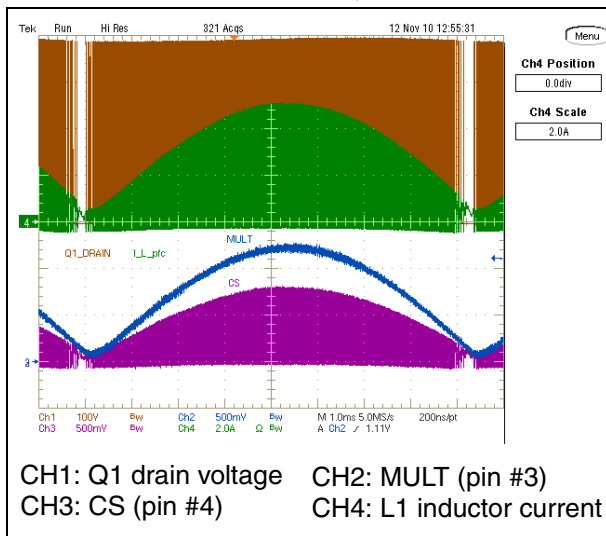

Figure 30. PFC Vds and inductor current at 115 Vac - 60 Hz, full load - detail

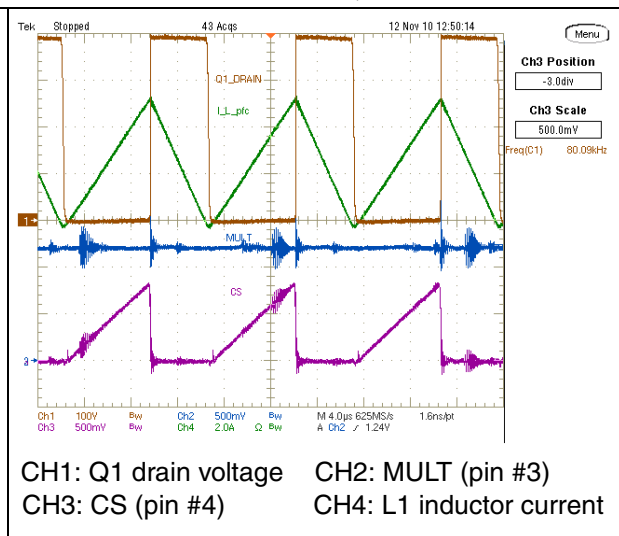

Figure 31 and Figure 32 show the same waveforms at 230 Vac. As the input voltage is higher than the inductor voltage, it is possible to observe the boost inductor resonating with the total drain capacitance with an amplitude of twice the inductor voltage on the offset of the input voltage. In order to maximize efficiency the RC network connected to the ZCD (#7) pin is tuned to make the turn-on of the MOSFET occur just on the valley of the drain voltage.

Figure 31. PFC Vds and inductor current at 230 Vac - 50 Hz, full load

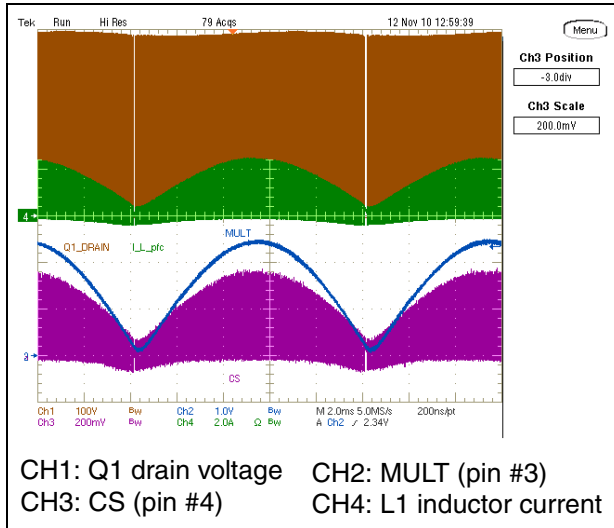
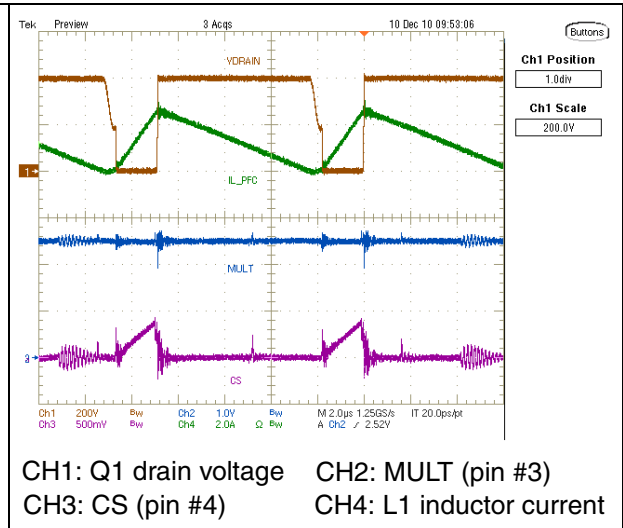

Figure 32. PFC Vds and inductor current at 230 Vac - 50 Hz, full load - detail



L6564 signals are shown in [Figure 33](#) and [34](#) for reference.

Figure 33. L6564 signals-1 at 115 Vac - 60 Hz, full load

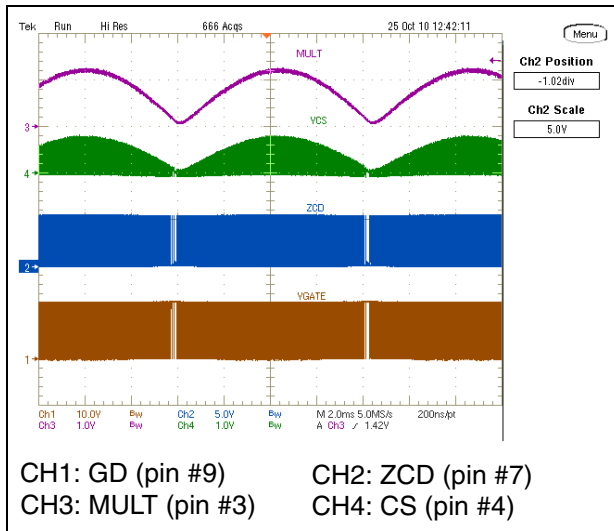
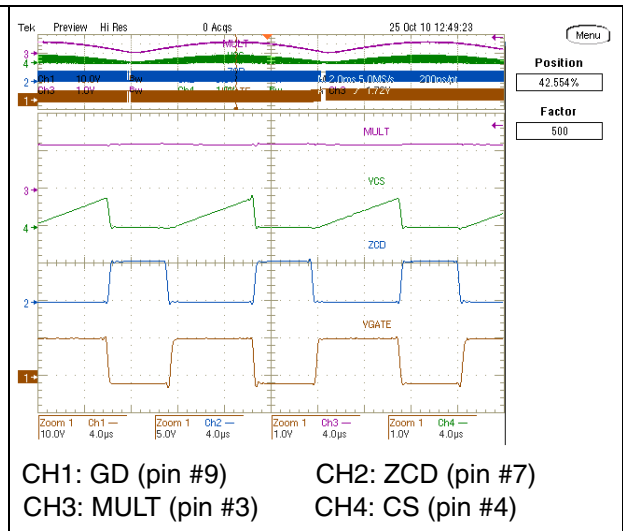

Figure 34. L6564 signals-2 at 115 Vac - 60 Hz, full load



[Figure 35](#) shows voltages on the VFF (#5), CS (#4), COMP (#2), and MULT (#3) pins along a line half-period at 115 Vac and 230 Vac respectively. Voltage feed-forward compensates for the gain and crossover frequency variation with the line voltage, since the power stage gain of PFC pre-regulators varies with the square of the RMS input voltage. Therefore, a DC voltage equal to the peak of the MULT (#3) pin is derived on the VFF (#5) pin and fed into a square/divider circuit making the COMP signal almost line-independent and improving the dynamic behavior. That is emphasized in [Figure 36](#), which illustrates voltage on the MULT (#3) pin at the peak of the line voltage matching that on the VFF pin.

Figure 35. PFC signals-1 at 115 Vac - 60 Hz, full load

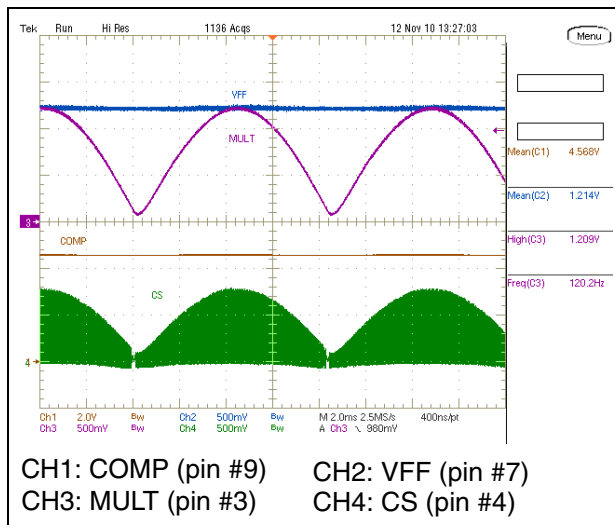
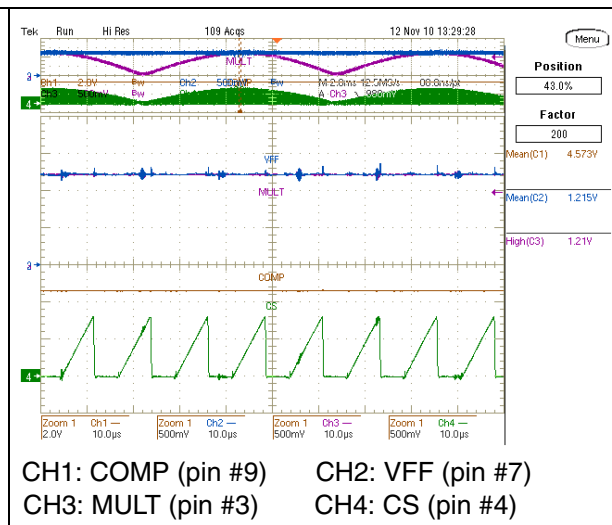

Figure 36. PFC signals-2 at 115 Vac - 60 Hz, full load



Resonant stage

Some waveforms relevant to the resonant stage during steady-state operation are reported in [Figure 37](#), [38](#), [39](#), [40](#), and [41](#). The switching frequency at full load and nominal input voltage is around 75 kHz, in order to achieve a good trade-off between transformer losses and size. [Figure 37](#) shows the resonant ZVS operation. The converter operates slightly below resonance, therefore, the resonant current lags the voltage applied, as input impedance of the resonant network is inductive. The current is negative during the rising edge of half bridge voltage and positive during the falling-edge, providing, in both cases, the energy to allow the node HB swinging. Because of the dead time, the MOSFETs are turned on when resonant current is flowing through their body diodes and drain-source voltage is almost zero. In [Figure 38](#) voltages on the L6599A LINE (#7), RFmin (#4), CF (#3), and LVG (#11) pins are observed. The switching frequency is programmed by the resistors connected to the RFmin (#4) pin, which provides an accurate 2 V reference. The current flowing out from the RFmin (#4) pin is internally mirrored and alternately charges and discharges the capacitor connected to CF (#3). LINE (#7) pin voltage enables and disables the resonant stage, preventing operation in capacitive mode.

Figure 37. Resonant stage waveforms at 115 V - 60 Hz, full load **Figure 38. Resonant stage waveforms at 115 V - 60 Hz, full load**

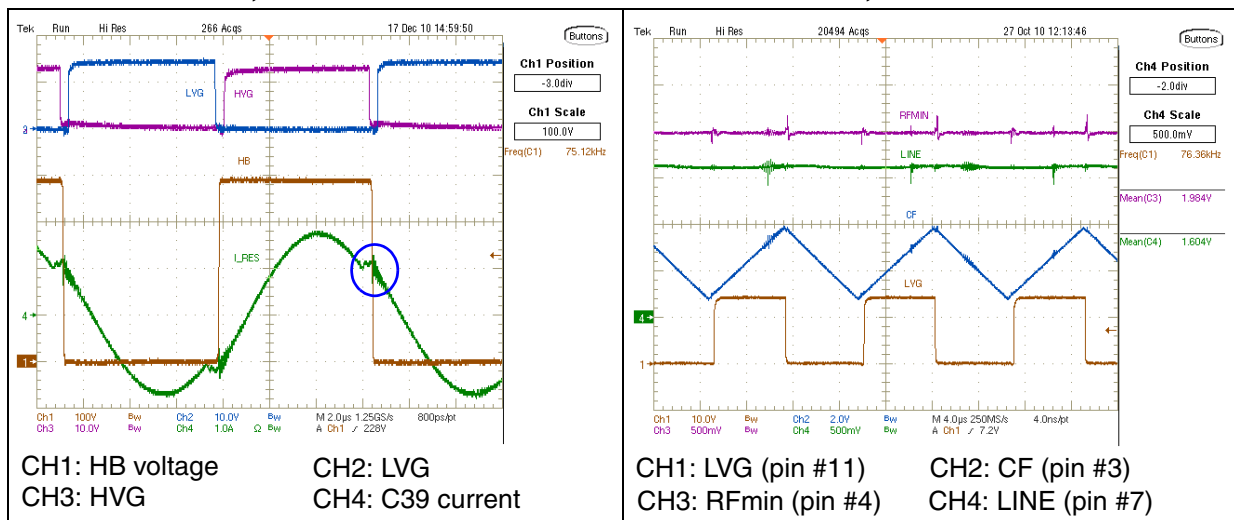

In [Figure 39](#) the reverse voltages across secondary rectifiers are represented. The system operates slightly below resonance and therefore the output rectifiers are working in discontinuous conduction mode, as energy transfer ends before each node HB voltage swinging. Therefore, at primary side there are some short intervals where both diodes are reverse-biased and the magnetizing inductance L_p , being no longer shunted by the output capacitance reflected to the primary, becomes part of resonance. This corresponds to the primary side current waveform to the portion circled in blue.

In the same image, it can be noted that the rectifiers PIV are operating within their voltage rating and well below the BV, so ensuring long term reliability.

Figure 39. Output rectifiers PIV waveforms

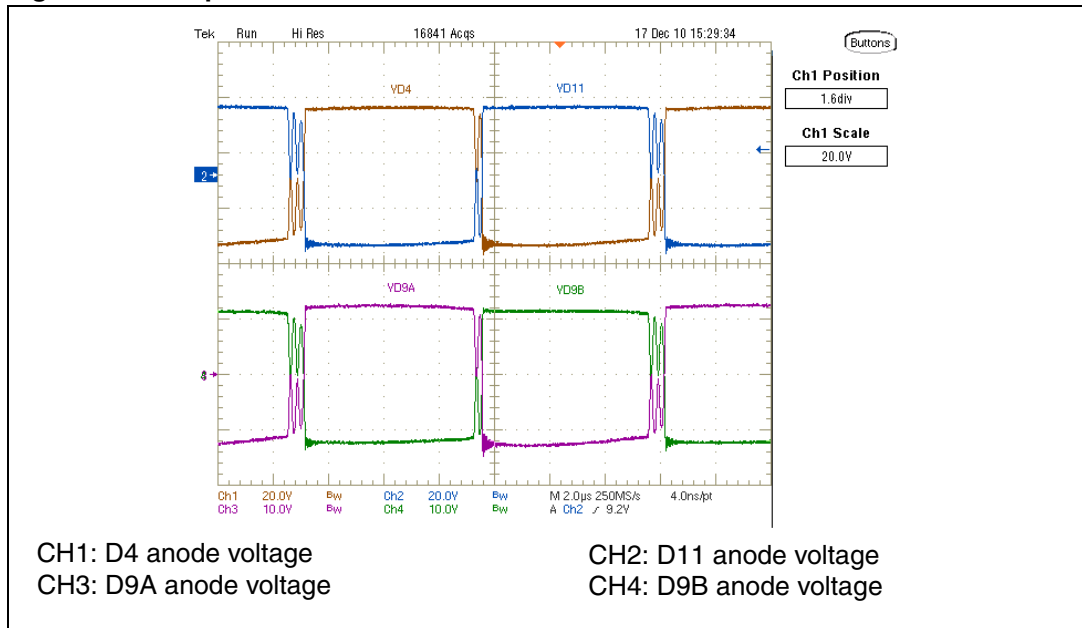

No load operation

In [Figure 40](#) and [41](#) operation at no load is shown. This check has been done for reference only, as typically a TV SMPS never works in such conditions. As seen, PFC is working in burst-mode, while the resonant stage is operating in continuous switching. This is possible by connecting the standby pin to the RFmin pin and it has been done to avoid any possible interference between the resonant stage and the TV circuitry. In [Figure 41](#) the half bridge maximum operating switching frequency is measured.

Figure 40. No load operation at 115 Vac - 60 Hz Figure 41. No load operation at 115 Vac - 60 Hz - L6599A signals

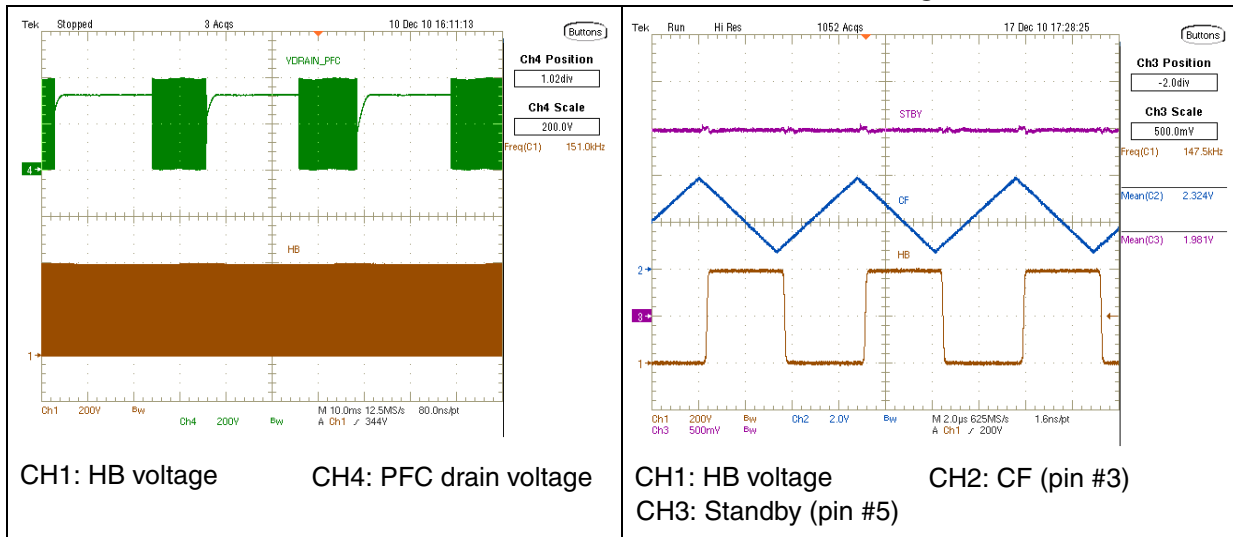

Dynamic load operation and output voltage regulation

Figure 42 and *43* show the output voltage regulation in the case of load transients on both the resonant stage outputs. The waveforms have been captured applying a load transient from 0 to full load to one output while the other is delivering full load. The period of load steps has been selected very long (1 s), to allow the output voltage to reach the steady-state condition and output voltage waveforms have been captured using the DC coupling of the scope to avoid waveform distortions caused by the AC coupling. A suitable offset has been also added to waveforms in order to get the maximum resolution.

Figure 42 reports the output voltage regulation with a dynamic load on 24 V output while the 12 V output is delivering the 2 A rated load. It can be noted that the 24 V output voltage has a tight variation, because even considering the spikes at the current edges, it is within $\pm 4\%$.

In the same way, in *Figure 43* it is possible to see the output voltage regulation with a dynamic load on the 12 V output, while the 24 V output is delivering the 6 A rated load. It can be noted that the 12 V output has a very tight variation - within $\pm 3\%$.

Figure 42. 12 V - 2 A; 24 V 0 ÷ 6 A transition at 115 Vac - 60 Hz **Figure 43. 24 V - 6 A; 12 V 0 ÷ 2 A transition at 115 Vac - 60 Hz**

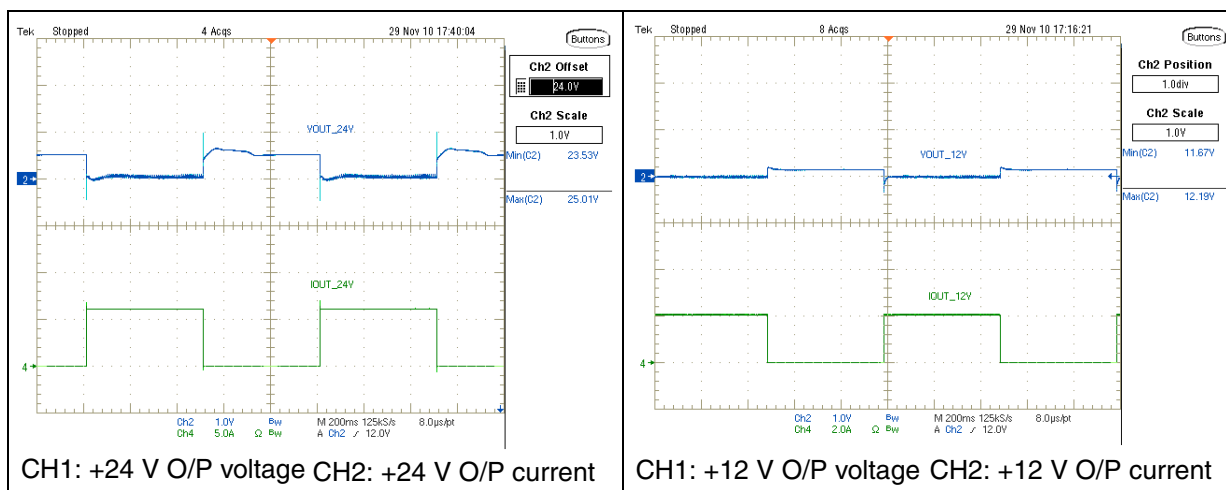

Cross regulation

Figure 44 and *45* show the output voltage cross regulation similar to previous tests but at 300 Hz load step frequency on one output, with the other delivering the rated load.

Figure 44 shows the simulation of the backlight and audio amplifier connected to the 24 V output. Load is varying from minimum to maximum and vice versa, as typically happens in a flat-TV because of backlight dimming and audio power amplifiers. Even in this condition, the 24 V output has a maximum deviation of $\pm 4\%$, mainly due to the series filter inductor L4. The 12 V output variation due to the dynamic load on 24 V (cross-regulation) is $\pm 2\%$, therefore very tight and suitable to power properly the internal logic of the LCD panel.

In *Figure 45* cross regulation between the 12 V and 24 V has been measured. In this image the 12 V load is changing from 1 to 2 A, as may happen when powering the LCD panel, and the variation of 24 V at rated load is measured. It can be noted in the image that the 12 V output has a deviation less than $\pm 1.2\%$, while the 24 V output variation due to the dynamic load on 12 V (cross-regulation) is $\pm 0.5\%$.

Figure 44. 12 V - 2 A; 24 V 0 ÷ 6 A - 300 Hz transition at 115 Vac - 60 Hz

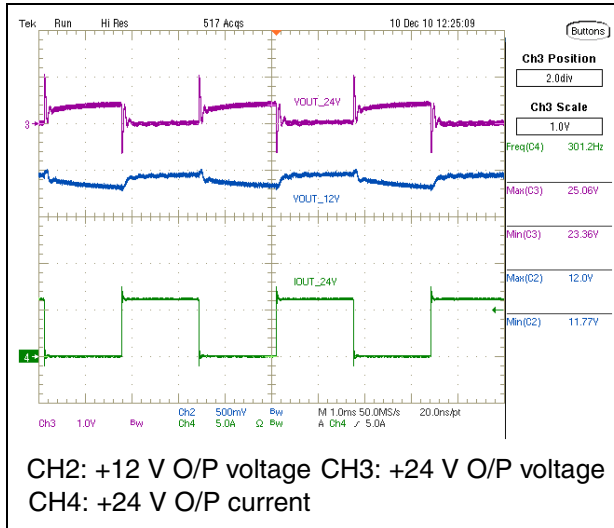
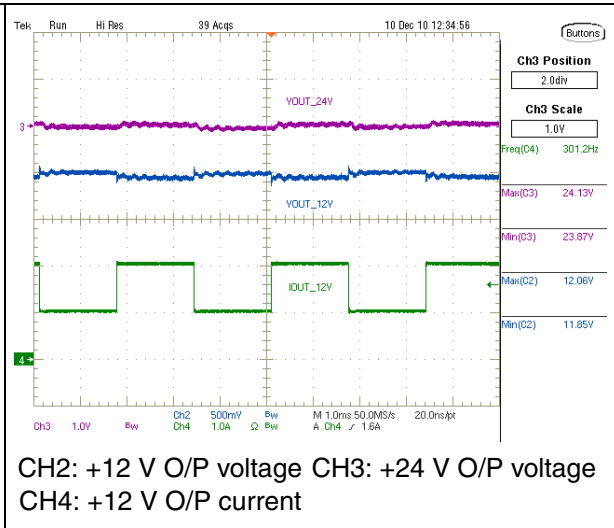

Figure 45. 24 V - 6 A; 12 V 1 ÷ 2 A - 300 Hz transition at 115 Vac - 60 Hz



Overcurrent and short-circuit protection

The L6599A is provided with a current sensing input (pin #6, ISEN) and a dedicated overcurrent management system. Current flowing in the resonant tank is detected and the signal is fed into the ISEN pin, which is internally connected to a first comparator, referenced to 0.8 V, and to a second comparator referenced to 1.5 V. If the voltage externally applied to the pin exceeds 0.8 V, the first comparator is tripped causing an internal switch to be turned on and discharge the soft-start capacitor CSS, increasing the switching frequency and so limiting the output power, while the second, referenced to 1.5 V, latches the L6599A, protecting the circuit against dead short-circuit. These two comparators, together with the DELAY pin (#2) are dedicated to offering the possibility of implementing the overload protection in either auto-restart or latch mode, according to the whole equipment needs. In this case, being a flat TV, the final application to which this demonstration board is dedicated, the desired overload and short protection is latched.

If the 12 V output is failing short-circuit as in *Figure 46*, the ISEN pin (#6) voltage rapidly rises over 1.5 V, triggering the second comparator of the overcurrent protection. In this case, as shown, the protection intervention is very quick, protecting properly the circuit. Then, the L6599A shuts down and operation can be resumed after an off-on signal or a mains voltage recycling. In *Figure 47* details of half bridge voltage and current during the higher current peaks have been captured, showing the correct ZVS operation by the circuit.

If the 24 V output is failing shorts (*Figure 48*), the L6599A ISEN pin reaches 0.8 V, triggers the first comparator, and the capacitor C10 connected to the DELAY and DIS pins, starts being charged by an internal 150 μA current generator while the soft-start capacitor C21 is discharged, increasing the switching frequency to limit the output power. When the voltage on the DELAY and DIS pins reaches 1.85 V, an internal comparator is triggered, then the L6599A is shut down and its consumption is reduced. The PFC_STOP pin is pulled down. The capacitor C10 is discharged by the external resistor R12. The latch condition is kept until the L6599A Vcc drops below the UVLO. Therefore, to resume the operation an off-on signal or a mains voltage recycling is necessary. *Figure 48* details HB switching transitions as soon as the short is detected, where the borderline between inductive and capacitive mode could be critical. As can be seen, the resonant current has the correct polarity during both HB transitions and the converter is properly working in the inductive region even in this case.

Figure 46. 12 V short-circuit at full load and 115 Vac - 60 Hz

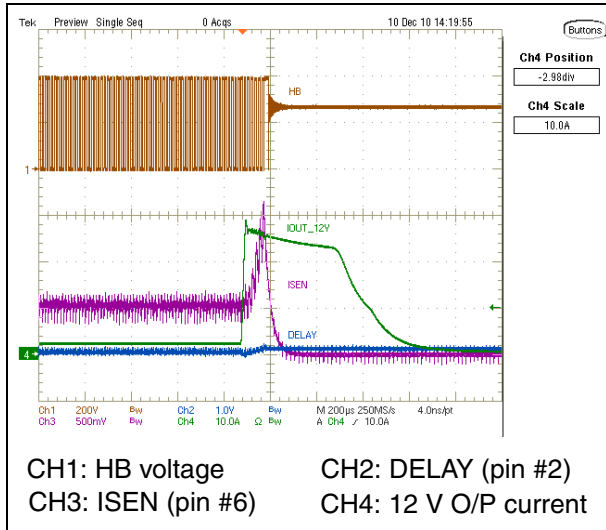

Figure 47. 12 V short-circuit at full load and 115 Vac - 60 Hz - detail

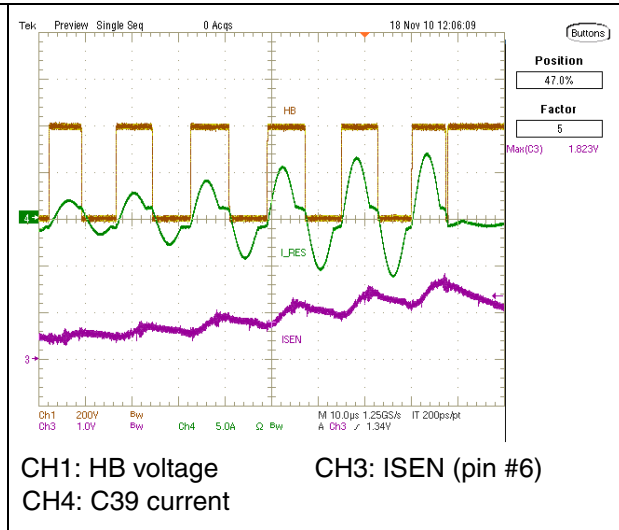

Figure 48. 24 V short-circuit at full load and 115 Vac - 60 Hz

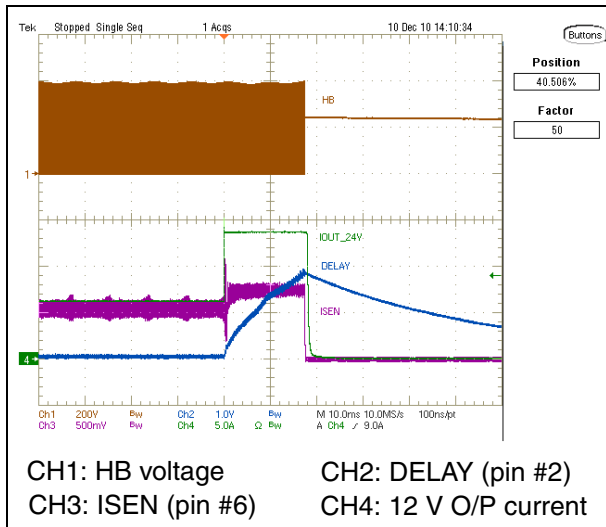
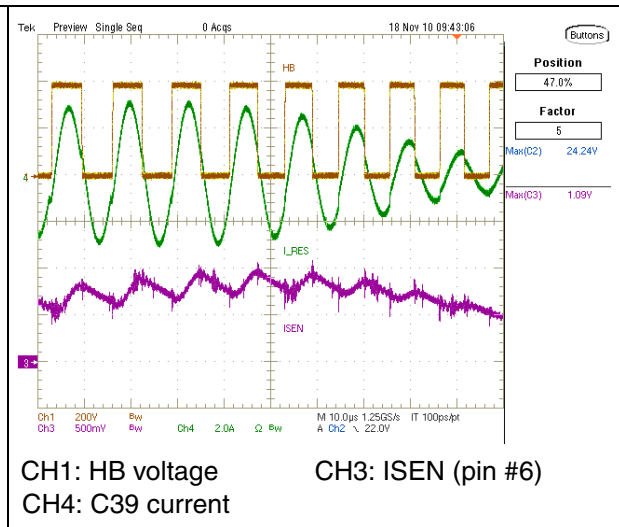

Figure 49. 24 V short-circuit at full load and 115 Vac - 60 Hz - detail



Startup

Figure 50 shows waveforms during startup at 115 Vac and full load of PFC and resonant stages. It is possible to note the sequence of the two stages; once the on/off signal is asserted high, voltage on C44 increases up to the Vcc turn-on thresholds of the L6564 and L6599A. The PFC starts first and its output voltage starts increasing from the mains rectified voltage to its nominal value. In the meantime, the L6599A is kept inactive by the LINE pin (#7) until the PFC voltage reaches the nominal output voltage, corresponding to 1.24 V on the LINE pin, then the resonant converter is enabled and starts switching. Figure 53 reports details of initial operation by the half bridge. It can be noted that the initial HB pulses are shorter than the following ones, and the resonant tank current has the correct polarity. This is achieved by means of the circuit R29, D8, C23, and R23, connected to the L6599A CF pin (#3). The purpose of this circuit is to provide an asymmetric operation by the half bridge MOSFETs during the initial pulses to prevent hard switching operation that may occur because the resonant capacitor C39 is discharged, and could damage the half bridge MOSFETs.

Figure 50. Startup by on-off signal at full load and 115 Vac - 60 Hz

Figure 51. Startup by on-off signal at full load and 115 Vac - 60 Hz - L6599A signals

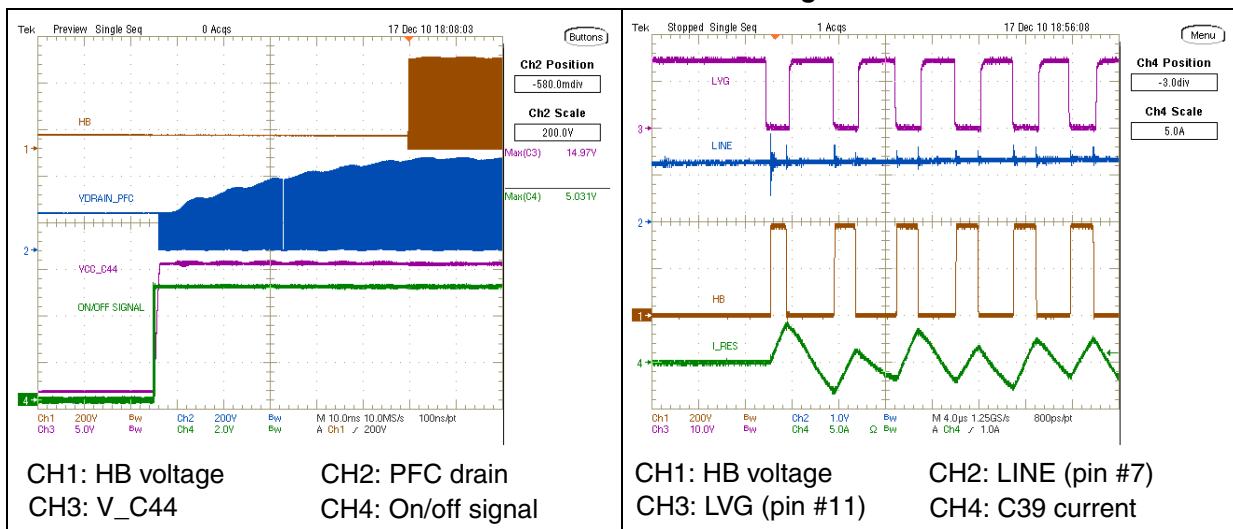

In Figure 52 the rising of the output voltages at startup has been captured. Note that the output voltages are reaching the steady-state level after ~90 ms when the on/off signal has been asserted high. The rising of the output voltages, controlled by C21 (CSS capacitor), is monotonic, regular, and without overshoots.

Figure 53 details the PFC and resonant converter turn-off. Note that after the on/off signal has been asserted low, the V_C44 decreases down to the L6564 and L6599A respective Vcc UVLO voltages and both converters stops switching correctly, without restarting attempts.

Figure 52. Startup by on/off signal at full load and 115 Vac - 60 Hz O/P voltage rising

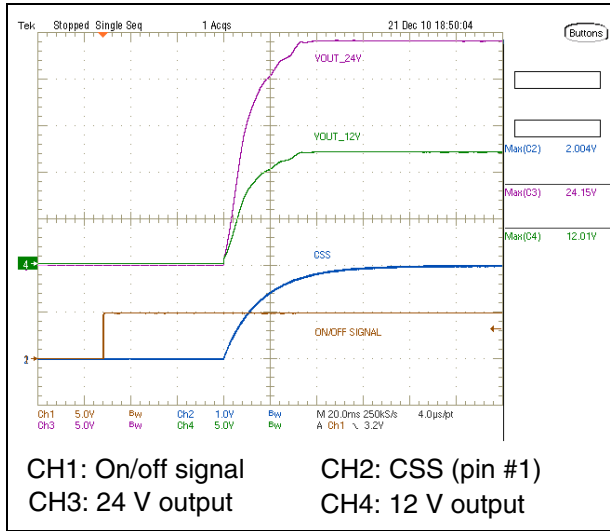
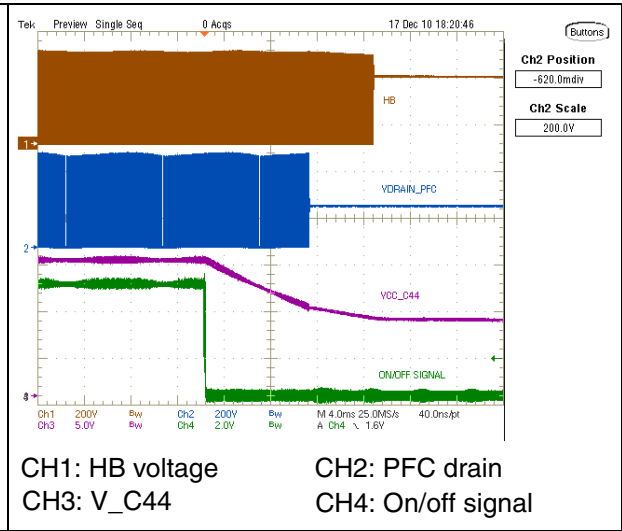

Figure 53. Turn-off at full load and 115 Vac - 60 Hz by on/off signal



Overvoltage protection

Figure 54 and 55 show the OVP response, observed opening the resonant stage feedback loop. Upon an overvoltage condition of either 24 V or 12 V output, the Zener diodes D16 and D17 are reverse-biased and conduct respectively, forcing Q10 on by the resulting base current, which causes Q9 to conduct shorting to ground the anode of the U5 optocoupler and the disappearance of V_C44. Therefore, the L6564 and the L6599A are not powered. The two transistors mentioned form a pnp-npn SCR structure that force the PFC and resonant converter to be latched off until the 5 V standby is removed by a mains voltage recycling. In the case of an open loop event, the 12 V and 24 V outputs reach 14.16 V and 28.26 V respectively.

Figure 54. OVP at full load and 115 Vac - 60 Hz on 12 V - 24 V

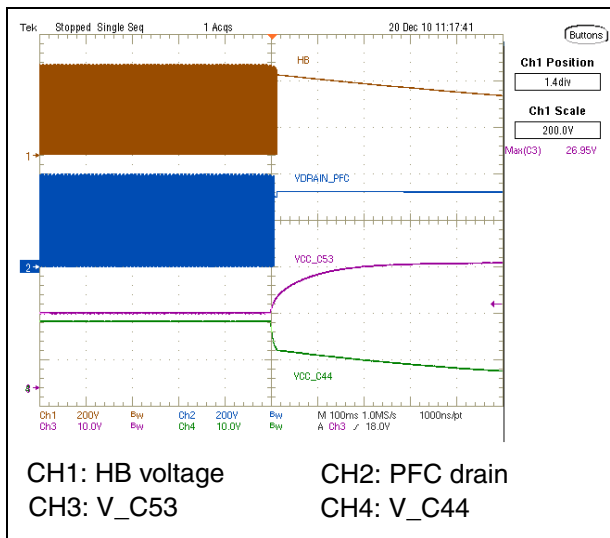
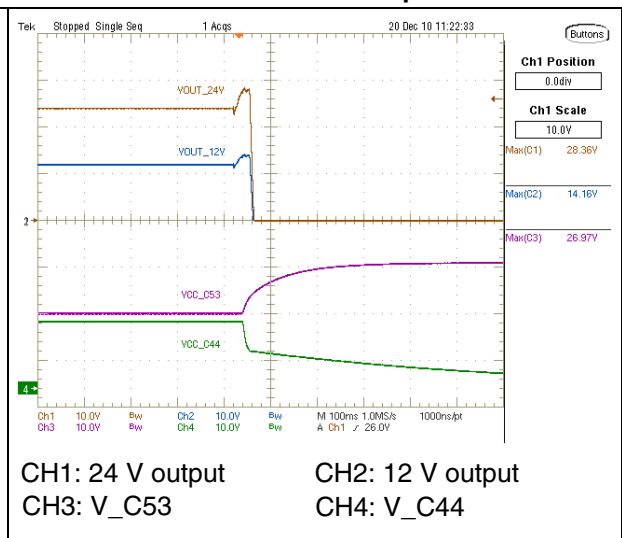

Figure 55. OVP at full load and 115 Vac - 60 Hz on 12 V - 24 V - outputs detail



Mains sags/dips

Figure 56 and 57 show the converter behavior in the case of half-cycle (8.3 ms) or a complete cycle (16.6 ms) mains dip. As can be noted, in both cases the PFC output voltage drops but the L6599A still works correctly, and output voltages do not show any disturbance, therefore demonstrating a good immunity of the circuit against mains dips.

Figure 56. Half cycle mains dip at full load and Figure 57. Full cycle mains dip at full load and 115 Vac - 60 Hz

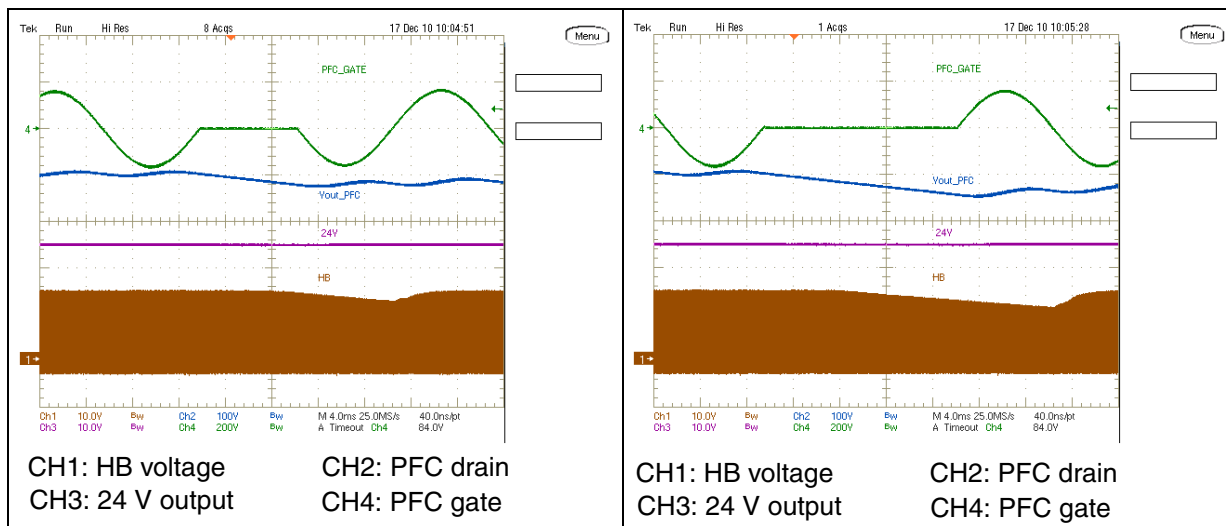

5 Conducted emission pre-compliance test

Figure 58, 59, 60, and 61 are the peak measurements of the conducted emission noise at full load and nominal mains voltages. The limits shown in the diagrams are EN55022 Class-B, which is the most popular norm for domestic equipment and has more severe limits compared to Class-A, dedicated to IT technology equipment. As visible in the diagrams, in all test conditions the measurements are far below the limits.

Figure 58. CE peak measurement at 115 V - 60 Hz and full load - phase wire

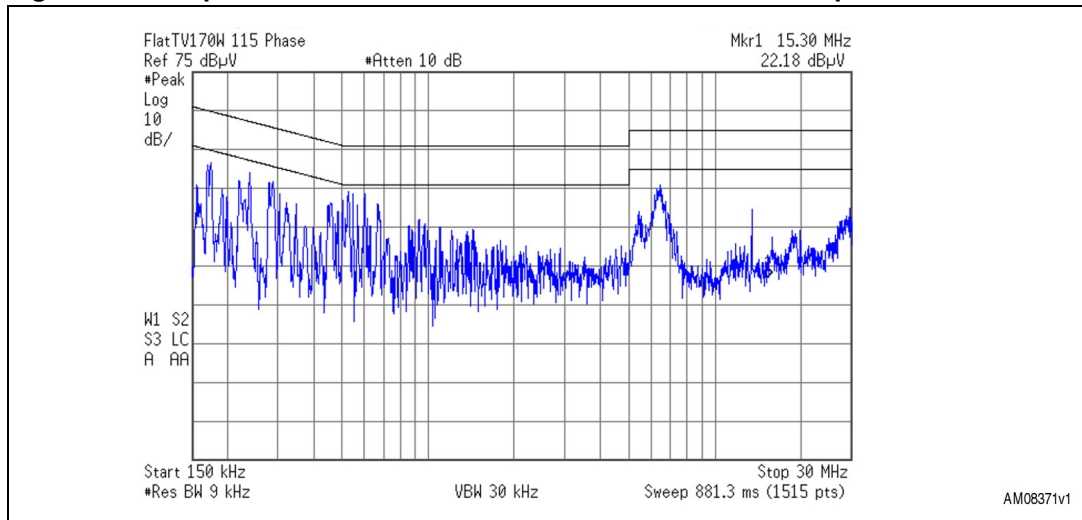

Figure 59. CE peak measurement at 115 V - 60 Hz and full load - neutral wire

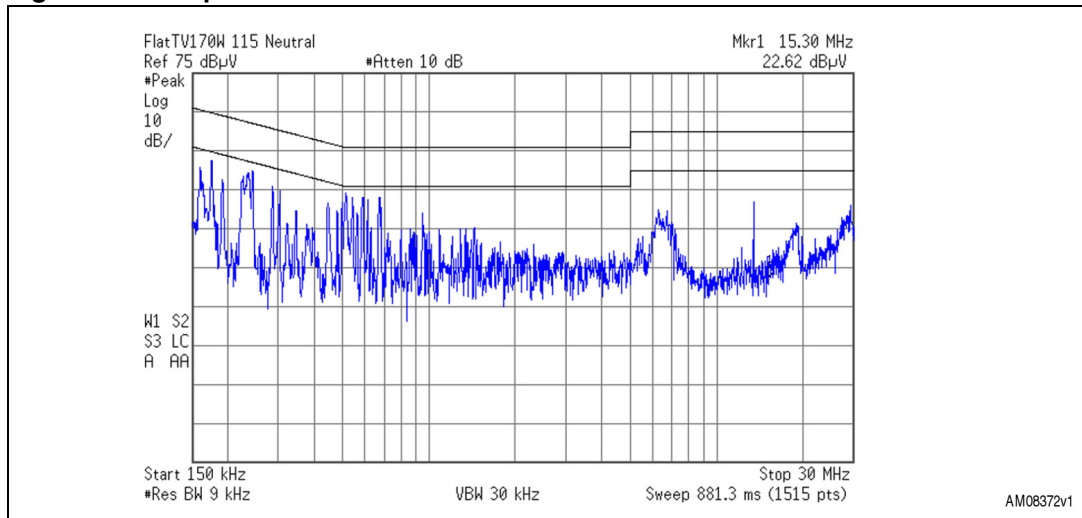

Figure 60. CE peak measurement at 230 V - 50 Hz and full load - phase wire

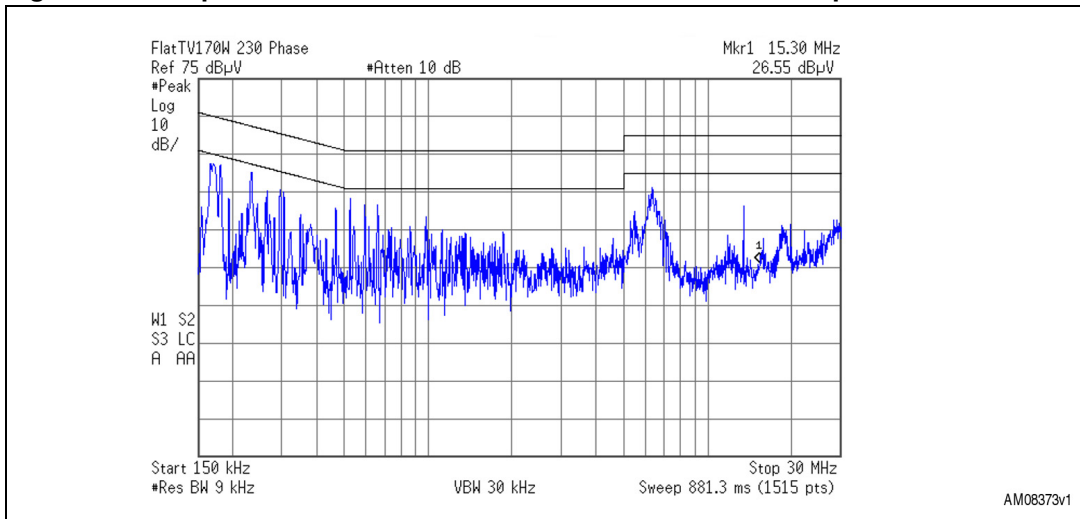
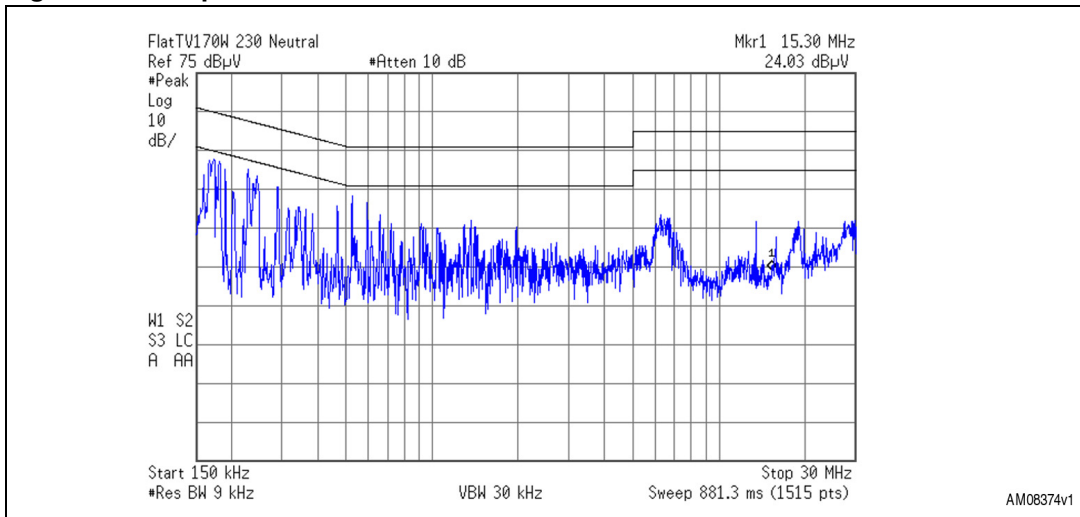

Figure 61. CE peak measurement at 230 V - 50 Hz and full load - neutral wire



6 Bill of materials

Table 2. Bill of materials

Des.	Part type / part value	Case style / package	Description	Supplier
C1	2.2 nF	DWG	Y1 - safety cap. DE1E3KX222M	MURATA
C10	100 nF	0805	50 V Ceracap - general purpose - X7R - 10 %	KEMET
C12	100 nF	1206	50 V Ceracap - general purpose - X7R - 10 %	KEMET
C13	47 nF	0805	50 V Ceracap - general purpose - X7R - 10 %	KEMET
C14	1000 µF - 35 V	Dia.12x25 p. 5 mm	Aluminium ELCAP - YXF series - 105 °C	Rubycon
C15	1000 µF - 35 V	Dia.12x25 p. 5 mm	Aluminium ELCAP - YXF series - 105 °C	Rubycon
C16	100 µF - 50 V	Dia.8x11 p. 3.5 mm	Aluminium ELCAP - YXF series - 105 °C	Rubycon
C17	100 nF	0805	50 V Ceracap - general purpose - X7R - 10 %	KEMET
C18	470 nF	1206	50 V Ceracap - general purpose - Y5V - 20 %	KEMET
C19	100 nF	0805	50 V Ceracap - general purpose - X7R - 10 %	KEMET
C2	1 µF - X2	11x26.5 mm p. 22.5	FLM CAP - B32923C3105K	EPCOS
C20	470 nF	0805	16 V Ceracap - general purpose - X7R - 10 %	KEMET
C21	4.7 µF - 6.3 V	0805	6.3 V Ceracap - general purpose - X5R - 15 %	KEMET
C23	4.7 nF	0805	50 V Ceracap - general purpose - X7R - 10 %	KEMET
C24	470 pF	0805	50 V Ceracap - general purpose - C0G - 5 %	KEMET
C25	2.2 nF	0805	50 V Ceracap - general purpose - X7R - 10 %	KEMET
C26	1000 µF - 25 V	Dia.12x20 p. 5 mm	Aluminium ELCAP - YXF series - 105 °C	RUBYCON
C27	100 µF - 50 V	Dia.8x11 p. 3.5 mm	Aluminium ELCAP - YXF series - 105 °C	RUBYCON
C28	100 nF	0805	50 V Ceracap - general purpose - X7R - 10 %	KEMET
C29	N.M.	0805	Not mounted	
C3	1 µF - X2	11x26.5 mm p. 22.5	FLM CAP - B32923C3105K	EPCOS
C30	470 nF	1206	50 V Ceracap - general purpose - Y5 V - 20 %	KEMET
C31	2.2 nF	0805	50 V Ceracap - general purpose - X7R - 10 %	KEMET
C32	1 µF	1206	16 V Ceracap - general purpose - X7R - 10 %	KEMET
C33	10 µF - 50 V	Dia. 6.3x11 (MM) p. 2.5 mm	Aluminium ELCAP - YXF series - 105 °C	Rubycon

Table 2. Bill of materials (continued)

Des.	Part type / part value	Case style / package	Description	Supplier
C34	220 pF	0805	50 V Cericap - general purpose - COG - 5 %	KEMET
C35	4.7 nF	1206	50 V Cericap - general purpose - X7R - 10 %	KEMET
C36	220 pF	1206	500 V Cericap - 12067A221JAT2A - C0G - 5 %	AVX
C38	220 nF	0805	16 V Cericap - general purpose - X7R - 10 %	KEMET
C39	33 nF	5.0x18.0 p. 15 mm	1 kV - MKP film capacitor B32652A0333J	EPCOS
C4	470 nF - 630 V	11x26.5mm p. 22.5	630 V - FLM CAP - B32613A6474K***	EPCOS
C40	47 µF - 50 V	Dia. 6.3x11 mm p. 2.5	Aluminium ELCAP - YXF series - 105 °C	Rubycon
C42	10 nF	0805	50 V Cericap - general purpose - X7R - 10 %	KEMET
C44	47 µF - 50 V	Dia. 6.3x11 mm p. 2.5 mm	Aluminium ELCAP - YXF series - 105 °C	Rubycon
C45	47 nF	0805	25 V Cericap - general purpose - X7R - 10 %	KEMET
C46	2.2 nF	DWG	Y1 - Safety CAP. DE1E3KX222M	MURATA
C47	10 µF - 450 V	Dia. 10 p. 5 mm	450 V - Aluminium ELCAP - VY series - 105 °C	Nichicon
C49	1000 µF - 10 V	Dia.10x16 p. 5 mm	Aluminium ELCAP - YXF series - 105 °C	Rubycon
C5	470 nF - 630 V	11x26.5mm p. 22.5	630 V - FLM CAP - B32613A6474K***	EPCOS
C50	1000 µF - 10 V	Dia.10x16 p. 5 mm	Aluminium ELCAP - YXF series - 105 °C	Rubycon
C51	220 µF - 16 V	Dia.8x11 p. 2 mm	Aluminium ELCAP - YXF series - 105 °C	Rubycon
C52	100 nF	0805	50 V Cericap - general purpose - X7R - 10 %	KEMET
C53	22 µF - 50 V	Dia. 5X11 p. 2 mm	Aluminium ELCAP - YXF series - 105°C	Rubycon
C54	100 nF	0805	50 V Cericap - general purpose - X7R - 10 %	KEMET
C55	2.2 nF	0805	50 V Cericap - general purpose - X7R - 10 %	KEMET
C56	100 nF	0805	50 V Cericap - general purpose - X7R - 10 %	KEMET
C59	10 nF	0805	50 V Cericap - general purpose - X7R - 10 %	KEMET
C6	100 µF - 450 V	Dia. 18x35 mm p.10	450 V - aluminium ELCAP - KXG series - 105 °C	Nippon Chemi-con
C60	100 nF	0805	50 V Cericap - general purpose - X7R - 10 %	KEMET
C61	10 nF	0805	50 V Cericap - general purpose - X7R - 10 %	KEMET

Table 2. Bill of materials (continued)

Des.	Part type / part value	Case style / package	Description	Supplier
C62	10 μ F - 50 V	Dia 6.3X11 (MM) p. 2.5 mm	Aluminium ELCAP - YXF series - 105°C	Rubycon
C63	10 nF	0805	50 V CerCap - general purpose - X7R - 10 %	KEMET
C64	1 nF	1206	100 V CerCap - general purpose - X7R - 10 %	KEMET
C65	220 pF	0805	50 V CerCap - general purpose - COG - 5 %	KEMET
C7	100 μ F - 450 V	Dia. 18x35 mm p.10	450 V - aluminium ELCAP - KXG series - 105 °C	Nippon Chemi-con
C8	2.2 nF	DWG	Y1 - Safety cap. DE1E3KX222M	MURATA
C9	2.2 nF	DWG	Y1 - Safety cap. DE1E3KX222M	MURATA
D1	1N5406	DO-201	Rectifier - general purpose	VISHAY
D10	1N4148WS	SOD323	High speed signal diode	VISHAY
D11	STPS20H100C FP	TO-220FP	Power Schottky rectifier	STMicroelectronics
D12	1N4148WS	SOD323	High speed signal diode	VISHAY
D14	1N4148WS	SOD323	High speed signal diode	VISHAY
D15	BZV55-C15	MINIMELF	Zener diode	VISHAY
D16	MMSZ4711-V	SOD123	27 V Zener diode	VISHAY
D17	MMSZ4702-V	SOD123	15 V Zener diode	VISHAY
D18	STPS20L45CFP	TO-220FP	Power Schottky rectifier	STMicroelectronics
D19	P6KE250A	DO-15	Transil	STMicroelectronics
D2	STTH5L06	DO-201	Ultrafast high voltage rectifier	STMicroelectronics
D20	STTH108A	SMA	HV ultrafast rectifier	STMicroelectronics
D21	BAV103	MINIMELF	High speed signal diode	VISHAY
D22	STTH102A	SMA	High efficiency ultrafast diode	STMicroelectronics
D3	D10XB60H	DWG	Single-phase bridge rectifier	SHINDENGEN
D4	STPS20H100C FP	TO-220FP	HV power Schottky rectifier	STMicroelectronics
D5	1N4148WS	SOD323	High speed signal diode	VISHAY
D6	1N4148WS	SOD323	High speed signal diode	VISHAY
D7	1N4148WS	SOD323	High speed signal diode	VISHAY
D8	1N4148WS	SOD323	High speed signal diode	VISHAY
D9	STPS20L45CFP	TO-220FP	Power Schottky rectifier	STMicroelectronics
F1	Fuse T4A	8.5x4 p.5.08 mm	Fuse 4 A - Time LAG - 3921400	Littelfuse
HS1	Heatsink	DWG	Heatsink for D3 and Q5	

Table 2. Bill of materials (continued)

Des.	Part type / part value	Case style / package	Description	Supplier
HS2	Heatsink	DWG	Heatsink for Q3 and Q6	
HS3	Heatsink	DWG	Heatsink for D4 and D11	
HS4	Heatsink	DWG	Heatsink for D18	
HS5	Heatsink	DWG	Heatsink for D9	
J1	09-65-2038	DWG	Connector-pitch 3.96 mm - 2 pins (1 removed) - KK	Molex
J2	280385-2	DWG	Connector - p. 2.54 mm - 8 x 2 rows - MODU-II	AMP
J3	280384-2	DWG	Connector - p. 2.54 mm - 4 x 2 rows - MODU-II	AMP
JPX1	Shorted		Wire jumper	
JPX10	Shorted		Wire jumper	
JPX11	Shorted		Wire jumper - insulated	
JPX12	Shorted		Wire jumper	
JPX13	Shorted		Wire jumper - insulated	
JPX14	Shorted		Wire jumper	
JPX15	Shorted		Wire jumper	
JPX16	Shorted		Wire jumper - insulated	
JPX17	Shorted		Wire jumper	
JPX18	Shorted		Wire jumper - insulated	
JPX19	Shorted		Wire jumper	
JPX2	Shorted		Wire jumper - insulated	
JPX20	Shorted		Wire jumper	
JPX21	Shorted		Wire jumper	
JPX22	Shorted		Wire jumper	
JPX23	Shorted		Wire jumper	
JPX24	Shorted		Wire jumper	
JPX25	Shorted		Wire jumper	
JPX3	Shorted		Wire jumper	
JPX4	Shorted		Wire jumper	
JPX5	Shorted		Wire jumper	
JPX6	Shorted		Wire jumper - insulated	
JPX7	Shorted		Wire jumper - insulated	
JPX8	Shorted		Wire jumper	
JPX9	Shorted		Wire jumper	
L1	240 μ H	DWG	2086.0001 - PFC inductor	MAGNETICA

Table 2. Bill of materials (continued)

Des.	Part type / part value	Case style / package	Description	Supplier
L2	3 mH	DWG	1606.0007 EMI filter	MAGNETICA
L3	70 μ H	26x13 mm	2190.0001 DM inductor	MAGNETICA
L4	2.2 μ H	DIA12 p. 5 mm	10610041 - 3 μ H - 11 A inductor	MAGNETICA
L5	1 μ H	DIA8 p. 5 mm	10710083 - 1 μ - 5 A inductor	MAGNETICA
L6	1 μ H	DIA8 p. 5 mm	10710083 - 1 μ - 5 A inductor	MAGNETICA
PCB	PCB rev. 2		Single Layer - 2 OZ. - CEM-1	
Q10	BC847C	SOT-23	NPN small signal BJT	VISHAY
Q11	BC847C	SOT-23	NPN small signal BJT	VISHAY
Q3	STF12NM50N	TO-220FP	N-channel Power MOSFET	STMicroelectronics
Q5	STF14NM50N	TO-220FP	N-channel Power MOSFET	STMicroelectronics
Q6	STF12NM50N	TO-220FP	N-channel Power MOSFET	STMicroelectronics
Q7	BC847C	SOT-23	NPN small signal BJT	VISHAY
Q8	BC847C	SOT-23	NPN small signal BJT	VISHAY
Q9	BC857C	SOT-23	PNP small signal BJT	VISHAY
R1	NTC 2R5-S237	DWG	NTC resistor P/N B57237S0259M000	EPCOS
R10	51 k Ω	0805	SMD standard film res - 1/8 W - 1 % - 100 ppm/ $^{\circ}$ C	VISHAY
R11	3.9 M Ω	1206	SMD standard film res - 1/4 W - 1 % - 100 ppm/ $^{\circ}$ C	VISHAY
R12	470 k Ω	0805	SMD standard film res - 1/8 W - 5 % - 250 ppm/ $^{\circ}$ C	VISHAY
R13	130 k Ω	0805	SMD standard film res - 1/8 W - 5 % - 250 ppm/ $^{\circ}$ C	VISHAY
R15	2.2 M Ω	1206	SMD standard film res - 1/4 W - 1 % - 100 ppm/ $^{\circ}$ C	VISHAY
R16	3.9 M Ω	1206	SMD standard film res - 1/4 W - 1 % - 100 ppm/ $^{\circ}$ C	VISHAY
R17	200 k Ω	1206	SMD standard film res - 1/4 W - 1 % - 100 ppm/ $^{\circ}$ C	VISHAY
R18	56 Ω	0805	SMD standard film res - 1/8 W - 5 % - 250 ppm/ $^{\circ}$ C	VISHAY
R2	2.2 M Ω	1206	SMD standard film res - 1/4 W - 1 % - 100 ppm/ $^{\circ}$ C	VISHAY
R20	100 k Ω	0805	SMD standard film res - 1/8 W - 5 % - 250 ppm/ $^{\circ}$ C	VISHAY
R21	10 Ω	0805	SMD standard film res - 1/8 W - 5 % - 250 ppm/ $^{\circ}$ C	VISHAY
R22	3.9 k Ω	1206	SMD standard film res - 1/4 W - 5 % - 250 ppm/ $^{\circ}$ C	VISHAY
R23	4.7 M Ω	0805	SMD standard film res - 1/8 W - 5 % - 250 ppm/ $^{\circ}$ C	VISHAY
R24	3.3 k Ω	1206	SMD standard film res - 1/4 W - 5 % - 250 ppm/ $^{\circ}$ C	VISHAY
R25	10 Ω	0805	SMD standard film res - 1/8 W - 5 % - 250 ppm/ $^{\circ}$ C	VISHAY
R27	2.2 Ω	0805	SMD standard film res - 1/8 W - 5 % - 250 ppm/ $^{\circ}$ C	VISHAY
R29	4.7 k Ω	1206	SMD standard film res - 1/4 W - 5 % - 250 ppm/ $^{\circ}$ C	VISHAY
R3	27 k Ω	0805	SMD standard film res - 1/8 W - 1 % - 100 ppm/ $^{\circ}$ C	VISHAY
R31	100 k Ω	0805	SMD standard film res - 1/8 W - 5 % - 250 ppm/ $^{\circ}$ C	VISHAY

Table 2. Bill of materials (continued)

Des.	Part type / part value	Case style / package	Description	Supplier
R32	22 Ω	0805	SMD standard film res - 1/8 W - 5 % - 250 ppm/ $^{\circ}$ C	VISHAY
R33	200 k Ω	0805	SMD standard film res - 1/8 W - 1 % - 100 ppm/ $^{\circ}$ C	VISHAY
R34	10 Ω	0805	SMD standard film res - 1/8 W - 5 % - 250 ppm/ $^{\circ}$ C	VISHAY
R36	13 k Ω	0805	SMD standard film res - 1/8 W - 1 % - 100 ppm/ $^{\circ}$ C	VISHAY
R37	6.2 k Ω	1206	SMD standard film res - 1/4 W - 5 % - 250 ppm/ $^{\circ}$ C	VISHAY
R38	0	0805	SMD standard film res - 1/8 W - 1 % - 100 ppm/ $^{\circ}$ C	VISHAY
R39	3.9 k Ω	1206	SMD standard film res - 1/4 W - 5 % - 250 ppm/ $^{\circ}$ C	VISHAY
R4	2.2 M Ω	1206	SMD standard film res - 1/4 W - 1 % - 100 ppm/ $^{\circ}$ C	VISHAY
R40	1 k Ω	0805	SMD standard film res - 1/8 W - 5 % - 250 ppm/ $^{\circ}$ C	VISHAY
R41	56 Ω	0805	SMD standard film res - 1/8 W - 5 % - 250 ppm/ $^{\circ}$ C	VISHAY
R43	1 M Ω	0805	SMD standard film res - 1/8 W - 1 % - 100 ppm/ $^{\circ}$ C	VISHAY
R44	100 k Ω	0805	SMD standard film res - 1/8 W - 5 % - 250 ppm/ $^{\circ}$ C	VISHAY
R45	10 k Ω	0805	SMD standard film res - 1/8 W - 1 % - 100 ppm/ $^{\circ}$ C	VISHAY
R46	220 Ω	1206	SMD standard film res - 1/4 W - 5 % - 250 ppm/ $^{\circ}$ C	VISHAY
R47	0	1206	SMD standard film res - 1/4 W - 1 % - 100 ppm/ $^{\circ}$ C	VISHAY
R49	33 k Ω	0805	SMD standard film res - 1/8 W - 1 % - 100 ppm/ $^{\circ}$ C	VISHAY
R5	2.2 M Ω	1206	SMD standard film res - 1/4 W - 1 % - 100 ppm/ $^{\circ}$ C	VISHAY
R50	180 k Ω	0805	SMD standard film res - 1/8 W - 1 % - 100 ppm/ $^{\circ}$ C	VISHAY
R51	0.47 Ω	PTH	PR01 - metal film res - 1 W - 5 % - 250 ppm/ $^{\circ}$ C	VISHAY
R52	0.47 Ω	PTH	PR01 - metal film res - 1 W - 5 % - 250 ppm/ $^{\circ}$ C	VISHAY
R53	100 Ω	1206	SMD standard film res - 1/4 W - 1 % - 100 ppm/ $^{\circ}$ C	VISHAY
R55	150 Ω	0805	SMD standard film res - 1/8 W - 5 % - 250 ppm/ $^{\circ}$ C	VISHAY
R56	5.6 k Ω	0805	SMD standard film res - 1/8 W - 5 % - 250 ppm/ $^{\circ}$ C	VISHAY
R57	51 Ω	0805	SMD standard film res - 1/8 W - 5 % - 250 ppm/ $^{\circ}$ C	VISHAY
R59	1 k Ω	0805	SMD standard film res - 1/8 W - 5 % - 250 ppm/ $^{\circ}$ C	VISHAY
R6	4.7 M Ω	1206	SMD standard film res - 1/4 W - 1 % - 100 ppm/ $^{\circ}$ C	VISHAY
R60	47 k Ω	0805	SMD standard film res - 1/8 W - 5 % - 250 ppm/ $^{\circ}$ C	VISHAY
R61	180 k Ω	0805	SMD standard film res - 1/8 W - 1 % - 100 ppm/ $^{\circ}$ C	VISHAY
R62	75 k Ω	0805	SMD standard film res - 1/8 W - 1 % - 100 ppm/ $^{\circ}$ C	VISHAY
R64	1 k Ω	0805	SMD standard film res - 1/8 W - 5 % - 250 ppm/ $^{\circ}$ C	VISHAY
R65	180 k Ω	0805	SMD standard film res - 1/8W - 5% - 250 ppm/ $^{\circ}$ C	VISHAY
R67	10 k Ω	0805	SMD standard film res - 1/8 W - 1 % - 100 ppm/ $^{\circ}$ C	VISHAY
R68	1 k Ω	0805	SMD standard film res - 1/8 W - 5 % - 250 ppm/ $^{\circ}$ C	VISHAY
R69	4.7 k Ω	0805	SMD standard film res - 1/8 W - 5 % - 250 ppm/ $^{\circ}$ C	VISHAY

Table 2. Bill of materials (continued)

Des.	Part type / part value	Case style / package	Description	Supplier
R7	2.2 M Ω	1206	SMD standard film res - 1/4 W - 1 % - 100 ppm/ $^{\circ}$ C	VISHAY
R70	10 k Ω	0805	SMD standard film res - 1/8 W - 5 % - 250 ppm/ $^{\circ}$ C	VISHAY
R71	4.7 k Ω	0805	SMD standard film res - 1/8 W - 5 % - 250 ppm/ $^{\circ}$ C	VISHAY
R72	1 k Ω	0805	SMD standard film res - 1/8 W - 5 % - 250 ppm/ $^{\circ}$ C	VISHAY
R73	1 k Ω	0805	SMD standard film res - 1/8 W - 5 % - 250 ppm/ $^{\circ}$ C	VISHAY
R74	2.7 k Ω	0805	SMD standard film res - 1/8 W - 5 % - 250 ppm/ $^{\circ}$ C	VISHAY
R75	1 Ω	PTH	NFR25H - axial fusible res - 1/2 W - 5 % - 100 ppm/ $^{\circ}$ C	VISHAY
R78	3.9 Ω	1206	SMD standard film res - 1/4 W - 5 % - 250 ppm/ $^{\circ}$ C	VISHAY
R79	390 k Ω	AXIAL Dia.1.6x3.6 mm	Axial STD film res - 1/8 W - 5 % - 100 ppm/ $^{\circ}$ C	VISHAY
R8	2.2 M Ω	1206	SMD standard film res - 1/4 W - 1 % - 100 ppm/ $^{\circ}$ C	VISHAY
R80	82 k Ω	0805	SMD standard film res - 1/8 W - 1 % - 100 ppm/ $^{\circ}$ C	VISHAY
R81	27 k Ω	0805	SMD standard film res - 1/8 W - 5 % - 250 ppm/ $^{\circ}$ C	VISHAY
R82	1 k Ω	0805	SMD standard film res - 1/8 W - 5 % - 250 ppm/ $^{\circ}$ C	VISHAY
R83	27 k Ω	0805	SMD standard film res - 1/8 W - 5 % - 250 ppm/ $^{\circ}$ C	VISHAY
R84	12 k Ω	0805	SMD standard film res - 1/8 W - 5 % - 250 ppm/ $^{\circ}$ C	VISHAY
R86	120 k Ω	0805	SMD standard film res - 1/8 W - 1 % - 100 ppm/ $^{\circ}$ C	VISHAY
R87	270 k Ω	0805	SMD standard film res - 1/8 W - 5 % - 250 ppm/ $^{\circ}$ C	VISHAY
R88	39 k Ω	0805	SMD standard film res - 1/8 W - 1 % - 100 ppm/ $^{\circ}$ C	VISHAY
R89	47 k Ω	0805	SMD standard film res - 1/8 W - 1 % - 100 ppm/ $^{\circ}$ C	VISHAY
R9	220 k Ω	0805	SMD standard film res - 1/8 W - 1 % - 100 ppm/ $^{\circ}$ C	VISHAY
R90	10 Ω	1206	SMD standard film res - 1/4 W - 5 % - 250 ppm/ $^{\circ}$ C	VISHAY
R91	220 k Ω	1206	SMD standard film res - 1/4 W - 5 % - 250 ppm/ $^{\circ}$ C	VISHAY
R92	2.7 k Ω	0805	SMD standard film res - 1/8 W - 5 % - 250 ppm/ $^{\circ}$ C	VISHAY
R93	2.2 Ω	AXIAL Dia.1.6x3.6 mm	Axial STD film res - 1/8 W - 5 % - 100 ppm/ $^{\circ}$ C	VISHAY
R94	22 k Ω	AXIAL Dia.1.6x3.6 mm	Axial STD film res - 1/8 W - 5 % - 100 ppm/ $^{\circ}$ C	VISHAY
R95	1 k Ω	0805	SMD standard film res - 1/8 W - 5 % - 250 ppm/ $^{\circ}$ C	VISHAY
R96	0.47 Ω	PTH	PR01 - metal film res - 1 W - 5 % - 250 ppm/ $^{\circ}$ C	VISHAY
RV1	300 Vac	Dia. 15x5 p. 7.5 mm	300 V metal oxide varistor - B72214S0301K101	EPCOS
RX2	0	1206	SMD standard film res - 1/4 W - 5 % - 250 ppm/ $^{\circ}$ C	VISHAY

Table 2. Bill of materials (continued)

Des.	Part type / part value	Case style / package	Description	Supplier
T1	1860.0014 Rev. 0.1		Resonant transformer	MAGNETICA
T2	1715.0059		Standby flyback TRAFO	MAGNETICA
U1	L6564D	SSOP10	10-pin transition mode PFC controller	STMicroelectronics
U2	L6599AD	SO-16	Improved HV resonant controller	STMicroelectronics
U3	SFH610A-2	DIP-4 - 10.16MM	Optocoupler	Infineon
U4	TL431ACZ	TO-92	Programmable shunt voltage reference	STMicroelectronics
U5	SFH610A-2	DIP-4 - 10.16MM	Optocoupler	Infineon
U6	VIPER27LN	DIP8	Offline HV converter	STMicroelectronics
U7	SFH610A-2	DIP-4 - 10.16MM	Optocoupler	Infineon
U8	TS431AZ	TO-92	Programmable shunt voltage reference	STMicroelectronics

7 PFC coil specifications

General description and characteristics

- Application type: consumer, home appliance
- Transformer type: open
- Coil former: vertical type, 6+6 pins
- Max. temp. rise: 45 °C
- Max. operating ambient temperature: 60 °C
- Mains insulation: n.a.
- Unit finishing: varnished

Electrical characteristics

- Converter topology: boost, transition mode
- Core type: PQ32/20-PC44 or equivalent
- Min. operating frequency: 30 kHz
- Typical operating frequency: 120 kHz
- Primary inductance: 240 $\mu\text{H} \pm 15\%$ at 1 kHz - 0.25 V ^(a)

Electrical diagram and winding characteristics

Figure 62. PFC coil electrical diagram

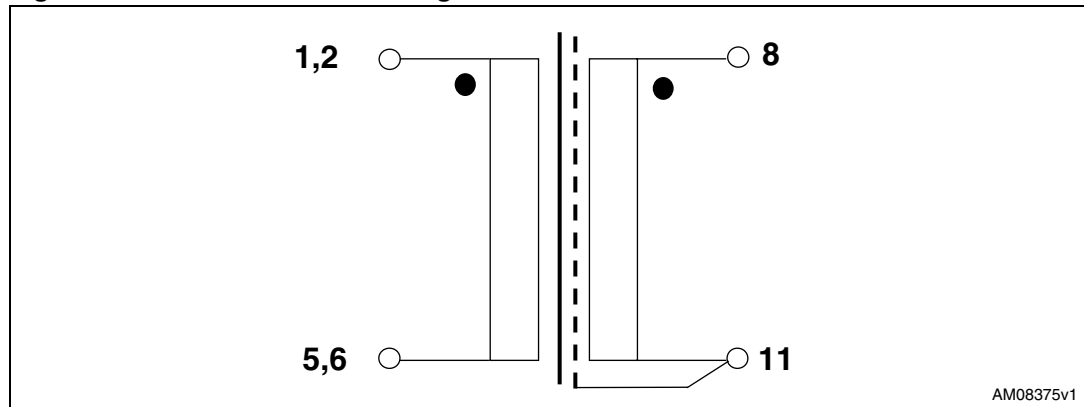

Table 3. PFC coil winding data

Pins	Windings	RMS current	Number of turns	Wire type
8 - 11	AUX	0.05 Arms	3	ϕ 0.3 mm - G2
1,2 - 5,6	Primary	2.65 Arms	28	2x40 ϕ 0.1 mm - G2

a. Measured between pins 1,2 and 5,6.

Mechanical aspect and pin numbering

- Maximum height from PCB: 22 mm
- Coil former type: vertical, 6+6 pins (pins #3, 4, 7, 12 are removed)
- Pin distance: 5.08 mm
- Row distance: 30.5 mm

Figure 63. PFC coil mechanical aspect

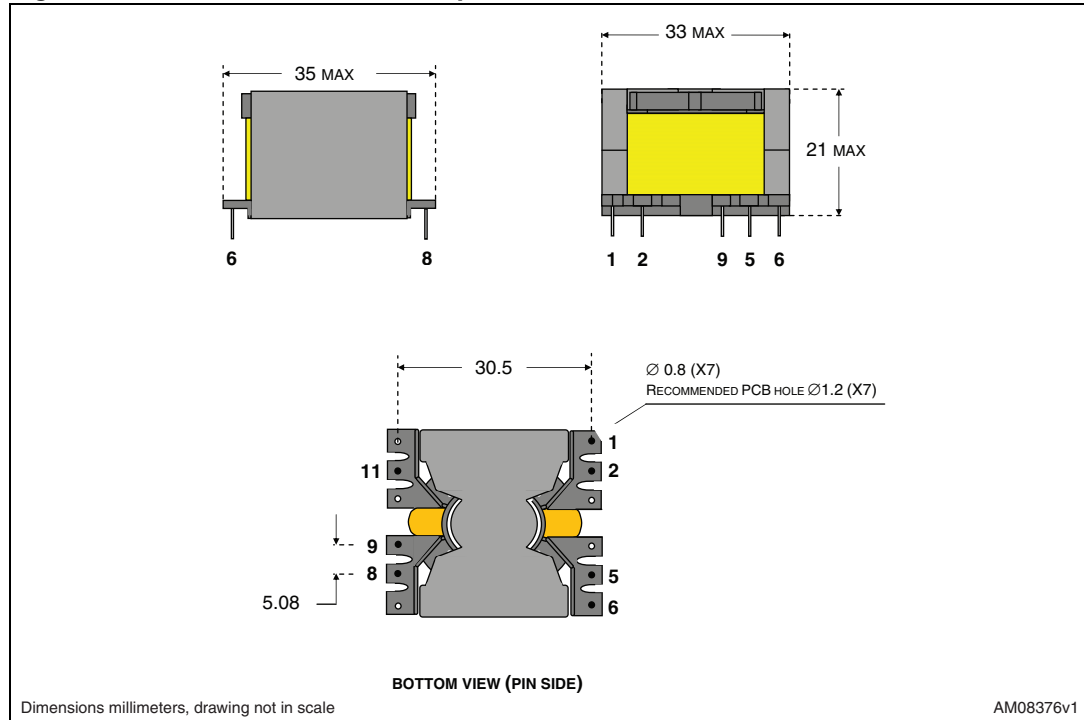

Manufacturer

- MAGNETICA
- Inductor P/N: 2086.0001

8 Resonant power transformer specifications

General description and characteristics

- Application type: consumer, home appliance
- Transformer type: open
- Coil former: horizontal type, 7+7 pins, two slots
- Max. temp. rise: 45 °C
- Max. operating ambient temperature: 60 °C
- Mains insulation: acc. to EN60065

Electrical characteristics

- Converter topology: half bridge, resonant
- Core type: ETD34-PC44 or equivalent
- Min. operating frequency: 70 kHz
- Typical operating frequency: 90 kHz
- Primary inductance: 660 $\mu\text{H} \pm 8\%$ at 1 kHz - 0.25 V^(b)
- Leakage inductance: 112 μH at 100 kHz - 0.25 V^(c)

Figure 64. Transformer overall drawing

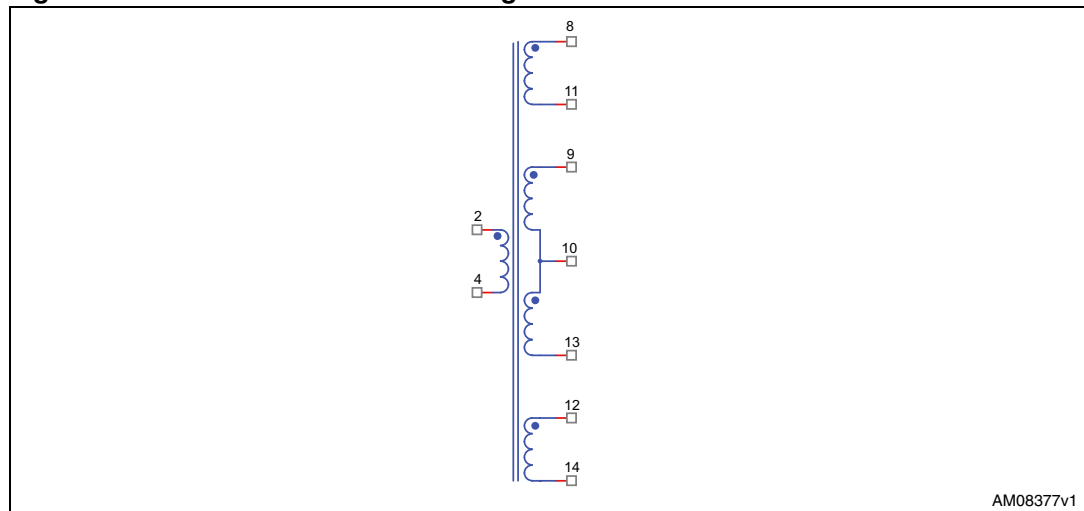

Table 4. Resonant transformer winding data

Pins	Winding	DC resistance	Number of turns	Wire type
2-4	Primary	158 m Ω	36	30x ϕ 0.1 mm – G1
6 - 7	AUX	94 m Ω	3	ϕ 0.28 mm – G2

b. Measured between pins 2-4.

c. Measured between pins 2-4 with secondary windings with same polarity shorted at time.

Table 4. Resonant transformer winding data (continued)

Pins	Winding	DC resistance	Number of turns	Wire type
8 - 11	SEC - A	4.4 mΩ	2	90xφ 0.1 mm – G1
9 - 10	SEC - B	4.4 mΩ	2	90xφ 0.1 mm – G1
10 - 13	SEC - C	4.4 mΩ	2	90xφ 0.1 mm – G1
12 - 14	SEC - D	4.4 mΩ	2	90xφ 0.1 mm – G1

Mechanical aspect and pin numbering

- Maximum height from PCB: 30 mm
- Coil former type: horizontal, 7+7 pins (pins #1 and 7 are removed)
- Pin distance: 5.08 mm
- Row distance: 25.4 mm

Figure 65. Transformer electrical diagram

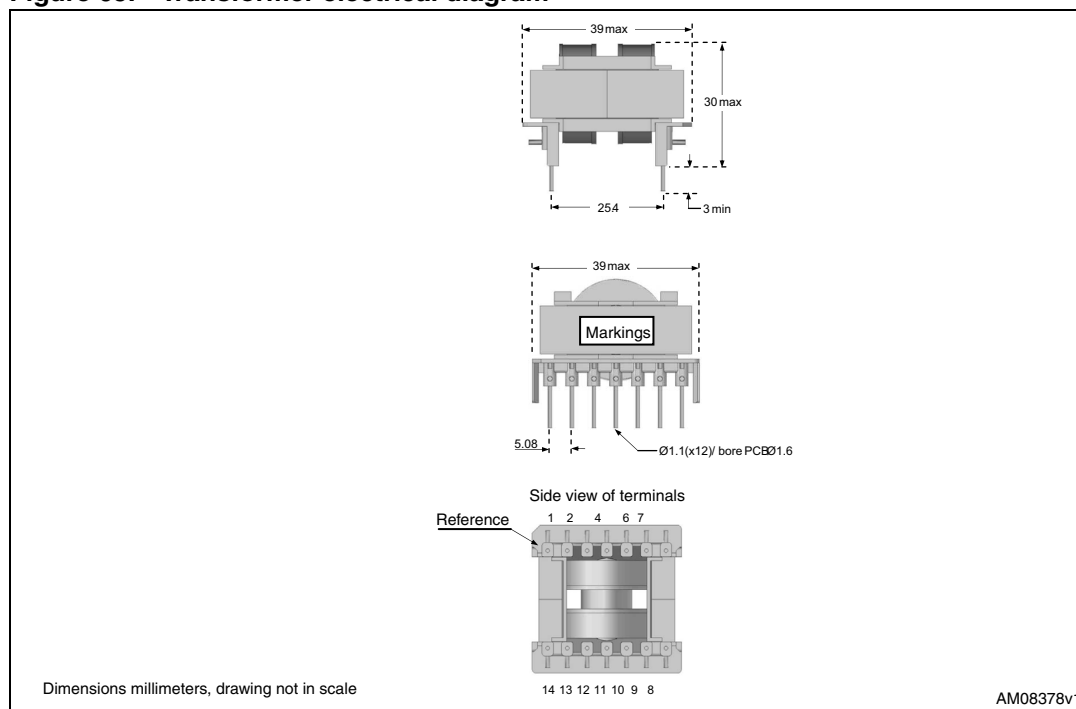

Manufacturer

- MAGNETICA
- Transformer P/N: 1860.0014 Rev. 0.1

9 Auxiliary flyback transformer specifications

General description and characteristics

- Application type: consumer, home appliance
- Transformer type: open
- Winding type: layer
- Coil former: horizontal type, 4+5 pins, two slots
- Max. temp. rise: 45 °C
- Max. operating ambient temperature: 60 °C
- Mains insulation: acc. to EN60950
- Unit finishing: varnished

Electrical characteristics

- Converter topology: flyback, CCM/DCM mode
- Core type: E20-PC44 or equivalent
- Typical operating frequency: 60 kHz
- Primary inductance: 2.380 mH \pm 10 % at 1 kHz - 0.25 V^(d)
- Leakage inductance: 30 μ H at 50 kHz - 0.25 V^(e)
- Max. peak primary current: 0.5 Apk
- RMS primary current: 0.17 Arms

DC output characteristics

- Converter topology: flyback, CCM/DCM mode

Table 5. DC output voltage and load

DC output voltage	DC load
5 V	2 A _{DC}
16 V	0.05 A _{DC}

d. Measured between pins 4-5.

e. Measured between pins 2-4 with secondary windings with same polarity shorted at time.

Figure 66. Transformer construction

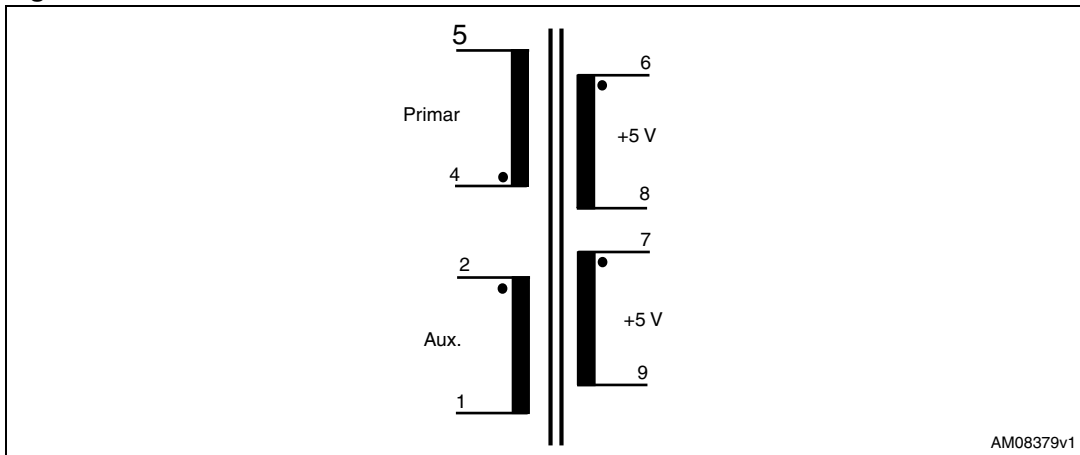

Winding characteristics

Table 6. Standby transformer winding data

Pins	Winding	O/P rms current	Number of turns	Number of layers	Wire type
4 - 5	Primary	0.17 A _{RMS}	93	2	G2 - ϕ 0.224 mm
2 - 1	Aux	0.05 A _{RMS}	18 spaced	1	G2 - ϕ 0.224 mm
6 - 8 7 - 9	5 V	2.6 A _{RMS} (TOTAL)	6	1	TIW - 2 x ϕ 0.7 mm in parallel

Figure 67. Mechanical aspect and pin numbering

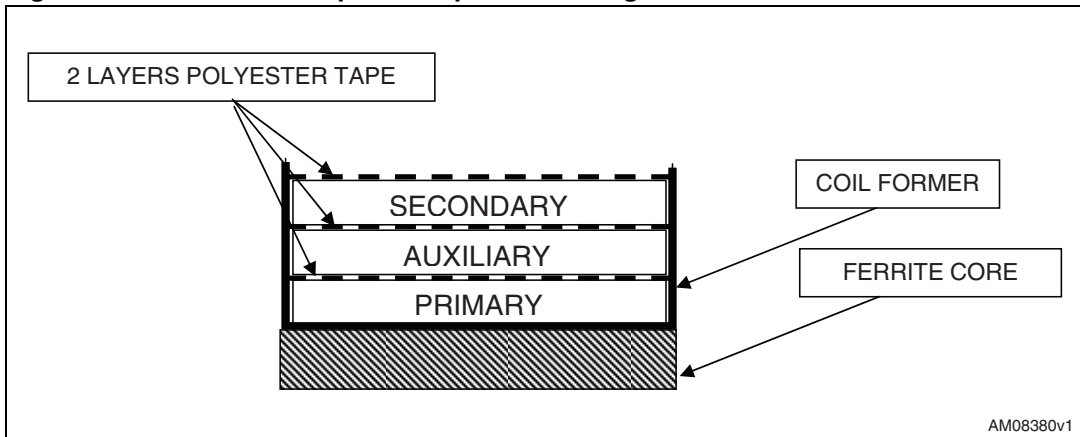
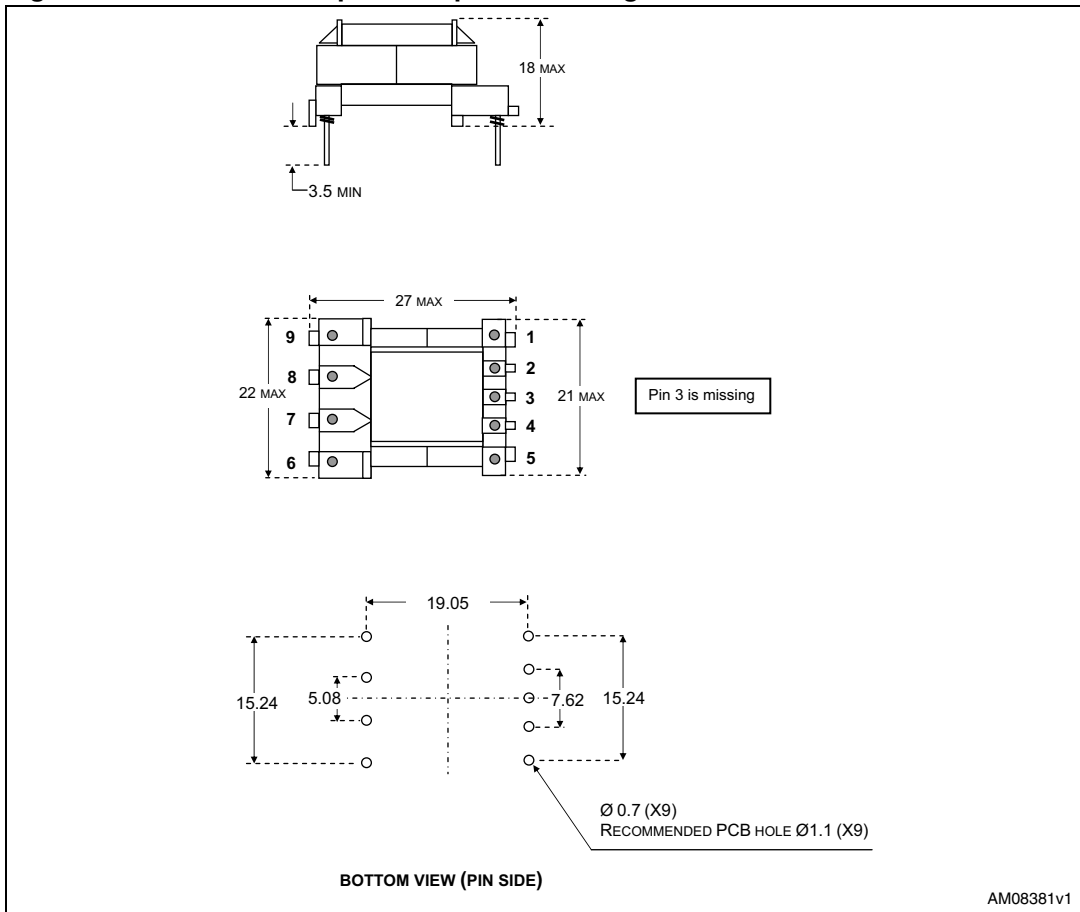

Figure 68. Mechanical aspect and pin numbering



Manufacturer

- MAGNETICA
- Inductor P/N: 1715.0059

10 Revision history

Table 7. Document revision history

Date	Revision	Changes
25-Feb-2011	1	Initial release.

Please Read Carefully:

Information in this document is provided solely in connection with ST products. STMicroelectronics NV and its subsidiaries ("ST") reserve the right to make changes, corrections, modifications or improvements, to this document, and the products and services described herein at any time, without notice.

All ST products are sold pursuant to ST's terms and conditions of sale.

Purchasers are solely responsible for the choice, selection and use of the ST products and services described herein, and ST assumes no liability whatsoever relating to the choice, selection or use of the ST products and services described herein.

No license, express or implied, by estoppel or otherwise, to any intellectual property rights is granted under this document. If any part of this document refers to any third party products or services it shall not be deemed a license grant by ST for the use of such third party products or services, or any intellectual property contained therein or considered as a warranty covering the use in any manner whatsoever of such third party products or services or any intellectual property contained therein.

UNLESS OTHERWISE SET FORTH IN ST'S TERMS AND CONDITIONS OF SALE ST DISCLAIMS ANY EXPRESS OR IMPLIED WARRANTY WITH RESPECT TO THE USE AND/OR SALE OF ST PRODUCTS INCLUDING WITHOUT LIMITATION IMPLIED WARRANTIES OF MERCHANTABILITY, FITNESS FOR A PARTICULAR PURPOSE (AND THEIR EQUIVALENTS UNDER THE LAWS OF ANY JURISDICTION), OR INFRINGEMENT OF ANY PATENT, COPYRIGHT OR OTHER INTELLECTUAL PROPERTY RIGHT.

UNLESS EXPRESSLY APPROVED IN WRITING BY AN AUTHORIZED ST REPRESENTATIVE, ST PRODUCTS ARE NOT RECOMMENDED, AUTHORIZED OR WARRANTED FOR USE IN MILITARY, AIR CRAFT, SPACE, LIFE SAVING, OR LIFE SUSTAINING APPLICATIONS, NOR IN PRODUCTS OR SYSTEMS WHERE FAILURE OR MALFUNCTION MAY RESULT IN PERSONAL INJURY, DEATH, OR SEVERE PROPERTY OR ENVIRONMENTAL DAMAGE. ST PRODUCTS WHICH ARE NOT SPECIFIED AS "AUTOMOTIVE GRADE" MAY ONLY BE USED IN AUTOMOTIVE APPLICATIONS AT USER'S OWN RISK.

Resale of ST products with provisions different from the statements and/or technical features set forth in this document shall immediately void any warranty granted by ST for the ST product or service described herein and shall not create or extend in any manner whatsoever, any liability of ST.

ST and the ST logo are trademarks or registered trademarks of ST in various countries.

Information in this document supersedes and replaces all information previously supplied.

The ST logo is a registered trademark of STMicroelectronics. All other names are the property of their respective owners.

© 2011 STMicroelectronics - All rights reserved

STMicroelectronics group of companies

Australia - Belgium - Brazil - Canada - China - Czech Republic - Finland - France - Germany - Hong Kong - India - Israel - Italy - Japan - Malaysia - Malta - Morocco - Philippines - Singapore - Spain - Sweden - Switzerland - United Kingdom - United States of America

www.st.com

