

Mini Half-Watt SMD 3.5mm (120° Viewing Angle)



OVS5MxBCR4 Series

Features:

- Compact Package Outline of 3.5 x 3.5 x 1.2 mm
- Robust energy-efficient design with long operating life
- Low thermal resistance
- Exceptional spatial uniformity
- Compatible to IR reflow soldering
- High Lumens output



Description:

The mini-half watt is an energy-efficient packaged LED source that offers high luminance, and a long operating lifespan. This device offers a 120° viewing angle and an ultra-low profile (1.2 mm) making it highly suitable for conventional lighting and specialized applications.

Applications:

- Automotive exterior and interior lighting
- Architectural indoor and outdoor lighting
- General lighting
- Display Backlighting
- Electronic signs and signals

Part Number	Viewing Angle	Emitted Color	Typ. Luminous Flux (lm)	Forward Voltage V_F	Power Dissipation @ 150 mA	Lens Color
OVS5MWBCR4	120	White	50	3.4	0.51 W	Clear
OVS5MWWBCR4		Warm White	30	3.6	0.54 W	
OVS5MBBCR4		Blue	8.2	3.4	0.51 W	
OVS5MGBCR4		Green	22	3.4	0.51 W	

Part Number	Viewing Angle	Emitted Color	Typ. Luminous Intensity (mcd)	Forward Voltage V_F	Power Dissipation @ 150 mA	Lens Color
OVS5MRBCR4	120	Red	7150	2.2	0.33 W	Clear
OVS5MABCR4		Amber	7150	2.2	0.33 W	
OVS5MYBCR4		Yellow	7150	2.2	0.33 W	

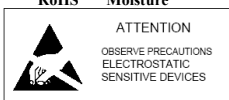
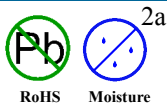

DO NOT LOOK DIRECTLY AT LED WITH UNSHIELDED EYES OR DAMAGE TO RETINA MAY

General Note

TT Electronics reserves the right to make changes in product specification without notice or liability. All information is subject to TT Electronics' own data and is considered accurate at time of going to print.

TT Electronics | OPTEK Technology
1645 Wallace Drive, Carrollton, TX 75006 | Ph: +1 972 323 2200
www.ttelectronics.com | www.optekinc.com

Mini Half-Watt SMD 3.5mm (120° Viewing Angle)



OVS5MxBCR4 Series

Electrical Specifications

Absolute Maximum Ratings (T _A = 25° C unless otherwise noted)				
	Red, Amber, Yellow	Green, Blue	White	Warm White
DC Forward Current	200 mA a	180 mA	180 mA	180 mA
Peak Pulsed Forward Current ¹	1000 mA	350 mA	350 mA	350 mA
Reverse Voltage	12V @ 10 uA	Not designed for reverse bias	Not designed for reverse bias	Not designed for reverse bias
Junction Temperature ²	125°C	125°C	125°C	125°C
Power Dissipation	750mW	750mW	750mW	750mW
Storage and Operating Temperature	-40° ~ +100 ° C	-40° ~ +100 ° C	-40° ~ +100 ° C	-40° ~ +100 ° C
ESD (JEDEC-JESD22-A114F)	Class 2	Class 2	Class 2	Class 2
MSL (IPC / JEDEC J-STD-020C)	2a / 672 Hrs	2a / 672 Hrs	2a / 672 Hrs	2a / 672 Hrs

Notes:

1. Pulse width $t_p \leq 10\mu s$, Duty cycle = 0.1
2. Thermal Resistance = 5 C/W

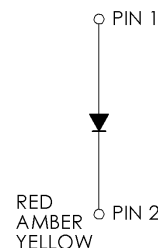
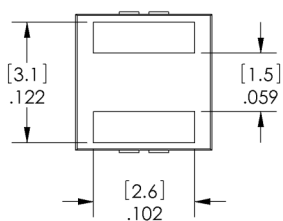
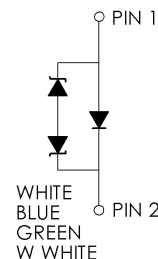
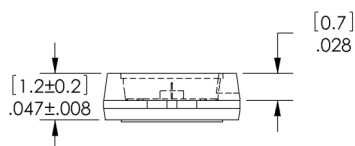
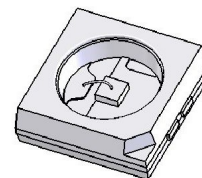
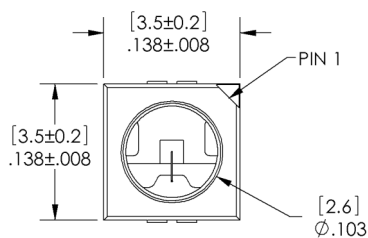

DIMENSIONS ARE IN INCHES [MM].

PIN 1	ANODE
PIN 2	CATHODE

General Note

TT Electronics reserves the right to make changes in product specification without notice or liability. All information is subject to TT Electronics' own data and is considered accurate at time of going to print.

TT Electronics | OPTEK Technology
1645 Wallace Drive, Carrollton, TX 75006 | Ph: +1 972 323 2200
www.ttelectronics.com | www.optekinc.com

Mini Half-Watt SMD 3.5mm (120° Viewing Angle)



OVS5MxBCR4 Series

Optical and Electrical Characteristics - Red, Amber, Yellow ($I_F = 140 \text{ mA}$, $T_A = 25^\circ \text{ C}$)

SYMBOL	PARAMETER	MIN	TYP	MAX	UNITS	
V_F	Forward Voltage	1.9	2.2	2.65	V	
Φ	Luminous Intensity	Red	4500	7150	9000	mcd
		Amber				
		Yellow				
λ_D	Dominant Wavelength	Red	620	625	630	nm
		Amber	610	615	621	
		Yellow	585	590	594	
I_R	Reverse Current @ 12 V	----	10	----	μA	
$2 \Theta_{1/2}$	50% Power Angle	----	120	----	deg	

Optical and Electrical Characteristics - Blue, Green ($I_F = 150 \text{ mA}$, $T_A = 25^\circ \text{ C}$)

SYMBOL	PARAMETER	MIN	TYP	MAX	UNITS	
V_F	Forward Voltage	3.0	3.4	3.9	V	
Φ	Luminous Flux	Blue	6.3	8.2	10.7	lm
		Green	18.1	22.0	30.6	
λ_D	Dominant Wavelength	Blue	460	465	470	nm
		Green	520	525	535	
$2 \Theta_{1/2}$	50% Power Angle	----	120	----	deg	

Optical and Electrical Characteristics - White, Warm White ($I_F = 150 \text{ mA}$, $T_A = 25^\circ \text{ C}$)

SYMBOL	PARAMETER	MIN	TYP	MAX	UNITS	
V_F	Forward Voltage	White	3.0	3.4	4.1	V
		Warm White		3.6		
Φ	Luminous Flux	White	30.6	50	67.2	lm
		Warm White	23.5	30	39.8	
$2 \Theta_{1/2}$	50% Power Angle	----	120	----	deg	

General Note

TT Electronics reserves the right to make changes in product specification without notice or liability. All information is subject to TT Electronics' own data and is considered accurate at time of going to print.

TT Electronics | OPTEK Technology
1645 Wallace Drive, Carrollton, TX 75006 | Ph: +1 972 323 2200
www.ttelectronics.com | www.optekinc.com

Mini Half-Watt SMD 3.5mm (120° Viewing Angle)



OVS5MxBCR4 Series

Standard Bins

LEDs are sorted to luminous intensity (I_V) or luminous flux (Φ) and dominant wavelength (nm) bins shown. Each reel consists of a single intensity bin and a single color bin. Orders are filled using all intensity and color bins listed in the following tables. Optek will not accept orders for single intensity bins or single color bins.

Luminous Flux (Φ) @ 150mA (lm)

Blue: OVS5MBBCR4		
IV Code	Min (lm)	Max (lm)
J2	6.3	7.1
J3	7.1	8.2
K2	8.2	9.3
K3	9.3	10.7
Green: OVS5MGBCR4		
IV Code	Min (lm)	Max (lm)
N2	18.1	20.6
N3	20.6	23.5
P2	23.5	26.8
P3	26.8	30.6

Dominant Wavelength (nm)

Blue: OVS5MBBCR4		
nm Code	Min (nm)	Max (nm)
A	460	465
B	465	470
Green: OVS5MGBCR4		
nm Code	Min (nm)	Max (nm)
A	520	525
B	525	530
C	530	535

Luminous Intensity (I_V) @ 140mA

Amber: OVS5MABCR4		
IV Code	Min (mcd)	Max (mcd)
Z1	4500	5600
Z2	5600	7150
AA	7150	9000
Red: OVS5MRBCR4		
IV Code	Min (mcd)	Max (mcd)
Z1	4500	5600
Z2	5600	7150
AA	7150	9000
Yellow: OVS5MYBCR4		
IV Code	Min (mcd)	Max (mcd)
Z1	4500	5600
Z2	5600	7150
AA	7150	9000

Dominant Wavelength (nm)

Amber: OVS5MABCR4		
nm Code	Min (nm)	Max (nm)
W	610	615
X	615	621
Red: OVS5MRBCR4		
nm Code	Min (nm)	Max (nm)
Full	620	630
Yellow: OVS5MYBCR4		
nm Code	Min (nm)	Max (nm)
X	585	588
Y	588	591
Z	591	594

General Note

TT Electronics reserves the right to make changes in product specification without notice or liability. All information is subject to TT Electronics' own data and is considered accurate at time of going to print.

TT Electronics | OPTEK Technology
1645 Wallace Drive, Carrollton, TX 75006 | Ph: +1 972 323 2200
www.ttelectronics.com | www.optekinc.com

Mini Half-Watt SMD 3.5mm (120° Viewing Angle)



OVS5MxBCR4 Series

Standard Bins (IF = 150mA)

LEDs are sorted to luminous flux (Φ) and chromaticity coordinates (x, y) bins shown. Each reel consists of a single intensity bin and a single chromaticity bin. Orders are filled using all intensity and chromaticity bins listed in the following table. Optek will not accept orders for single intensity bins or single chromaticity bins.

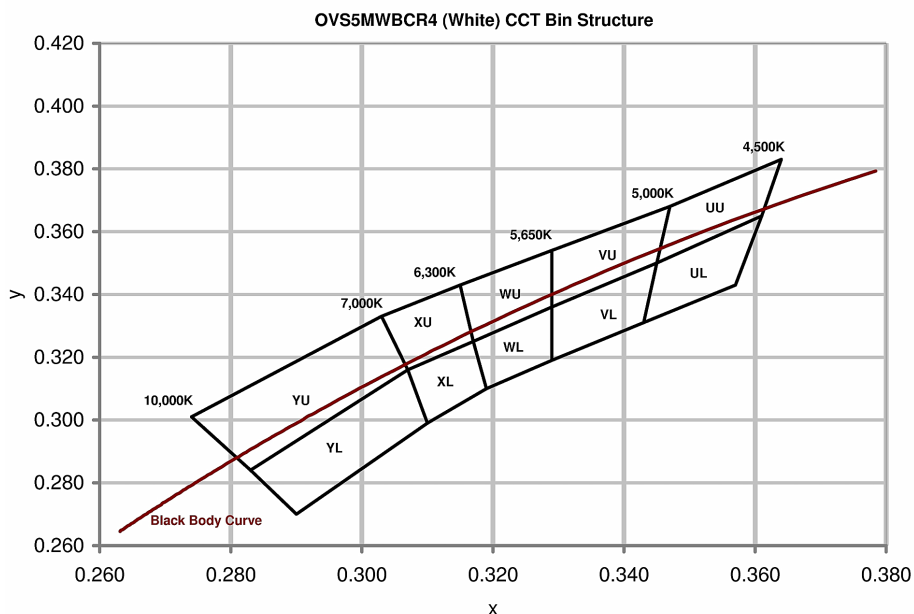

Chromaticity Coordinates (x, y)

Rank	YU				YL			
Cx	0.274	0.283	0.307	0.303	0.283	0.290	0.310	0.307
Cy	0.301	0.284	0.316	0.333	0.284	0.270	0.299	0.316
Rank	XU				XL			
Cx	0.303	0.307	0.317	0.315	0.307	0.310	0.319	0.317
Cy	0.333	0.316	0.325	0.343	0.316	0.299	0.310	0.325
Rank	WU				WL			
Cx	0.315	0.317	0.329	0.329	0.317	0.319	0.329	0.329
Cy	0.343	0.325	0.336	0.354	0.325	0.310	0.319	0.336
Rank	VU				VL			
Cx	0.329	0.329	0.345	0.347	0.329	0.329	0.343	0.345
Cy	0.354	0.336	0.350	0.368	0.336	0.319	0.331	0.350
Rank	UU				UL			
Cx	0.347	0.345	0.361	0.364	0.345	0.343	0.357	0.361
Cy	0.368	0.350	0.365	0.383	0.350	0.331	0.343	0.365

Φ	Luminous Flux (lm)	
Bin	Min	Max
Q2	30.6	34.8
Q3	34.8	39.8
R2	39.8	45.2
R3	45.2	51.7
S2	51.7	59.0
S3	59.0	67.2

General Note

TT Electronics reserves the right to make changes in product specification without notice or liability. All information is subject to TT Electronics' own data and is considered accurate at time of going to print.

TT Electronics | OPTEK Technology
1645 Wallace Drive, Carrollton, TX 75006 | Ph: +1 972 323 2200
www.ttelectronics.com | www.optekinc.com

Mini Half-Watt SMD 3.5mm (120° Viewing Angle)



OVS5MxBCR4 Series

Standard Bins (IF = 150mA)

LEDs are sorted to luminous flux (Φ) and chromaticity coordinates (x, y) bins shown. Each reel consists of a single intensity bin and a single chromaticity bin. Orders are filled using all intensity and chromaticity bins listed in the following table. Optek will not accept orders for single intensity bins or single chromaticity bins.

OVS5MWWBCR4 (Warm White) CCT Bin Structure

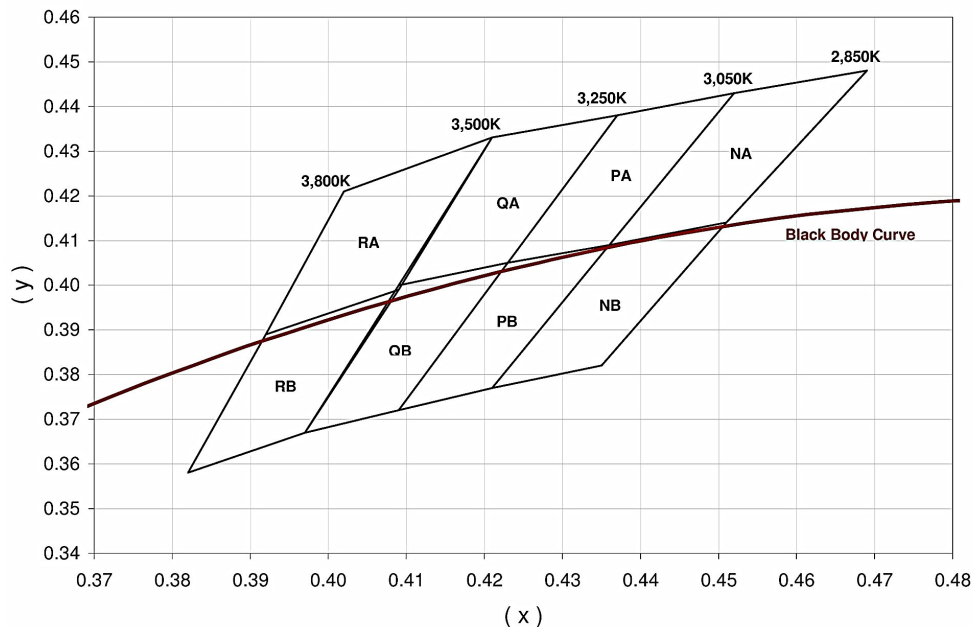

Chromaticity Coordinates (x, y)

Rank	RA				RB			
Cx	0.402	0.392	0.409	0.421	0.392	0.382	0.397	0.409
Cy	0.421	0.389	0.399	0.433	0.389	0.358	0.367	0.399
Rank	QA				QB			
Cx	0.421	0.409	0.423	0.437	0.409	0.397	0.409	0.423
Cy	0.433	0.400	0.405	0.438	0.400	0.367	0.372	0.405
Rank	PA				PB			
Cx	0.437	0.423	0.436	0.452	0.423	0.409	0.421	0.436
Cy	0.438	0.405	0.409	0.443	0.405	0.372	0.377	0.409
Rank	NA				NB			
Cx	0.452	0.436	0.451	0.469	0.436	0.421	0.435	0.451
Cy	0.443	0.409	0.414	0.448	0.409	0.377	0.382	0.414

Φ	Luminous Flux (lm)	
Bin	Min	Max
P2	23.5	26.8
P3	26.8	30.6
Q2	30.6	34.8
Q3	34.8	39.8

General Note

TT Electronics reserves the right to make changes in product specification without notice or liability. All information is subject to TT Electronics' own data and is considered accurate at time of going to print.

TT Electronics | OPTEK Technology
1645 Wallace Drive, Carrollton, TX 75006 | Ph: +1 972 323 2200
www.ttelectronics.com | www.optekinc.com

Mini Half-Watt SMD 3.5mm (120° Viewing Angle)



OVS5MxBCR4 Series

OVS5MABCR4 (Amber), OVS5MRBCR4 (Red) and OVS5MYBCR4 (Yellow)

Relative Intensity Vs Forward Current

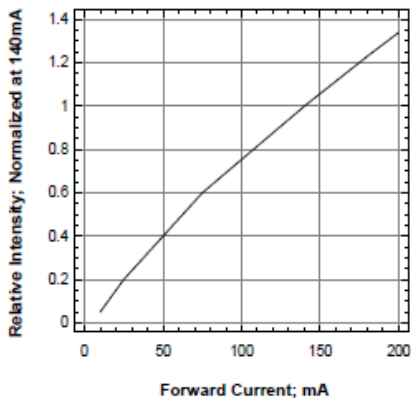

Forward Voltage Vs Forward Current

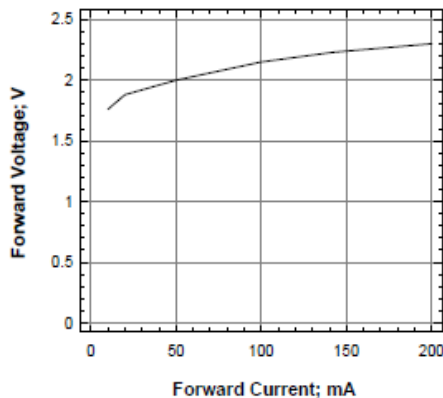

Maximum Current Vs Ambient Temperature

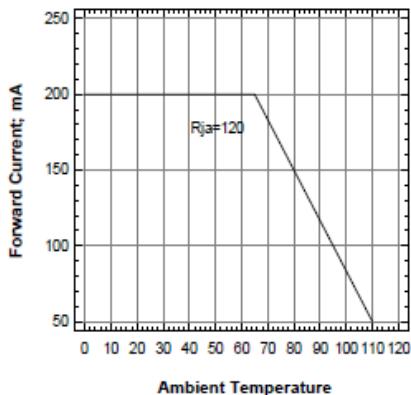

Maximum Current vs Solder-Point Temperature

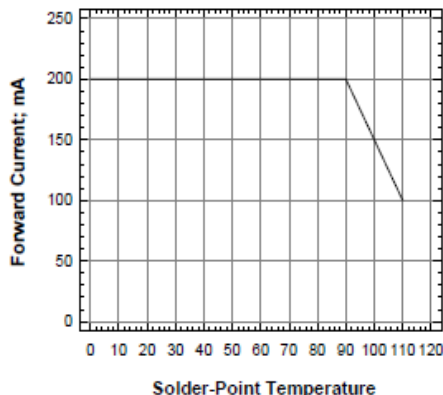

Relative Intensity Vs Wavelength

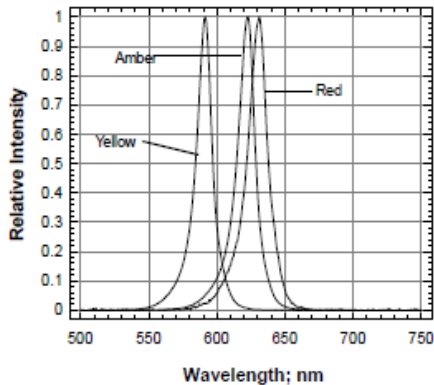

Allowable Forward Current Vs Duty Ratio

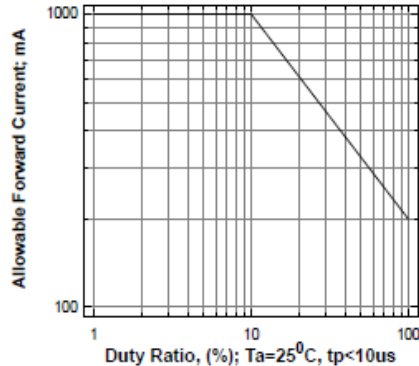

General Note

TT Electronics reserves the right to make changes in product specification without notice or liability. All information is subject to TT Electronics' own data and is considered accurate at time of going to print.

TT Electronics | OPTEK Technology
1645 Wallace Drive, Carrollton, TX 75006 | Ph: +1 972 323 2200
www.ttelectronics.com | www.optekinc.com

Mini Half-Watt SMD 3.5mm (120° Viewing Angle)



OVS5MxBCR4 Series

OVS5MBCR4 (Blue), OVS5MGBCR4 (Green), OVS5MWBCR4 (White) and OVS5MWWBCR4 (Warm White)

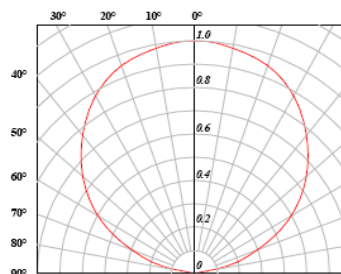
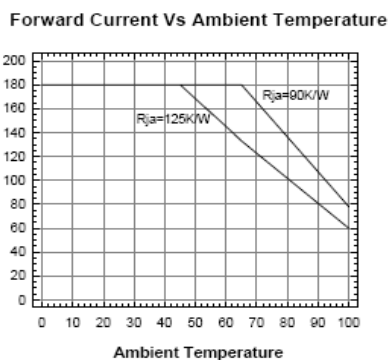
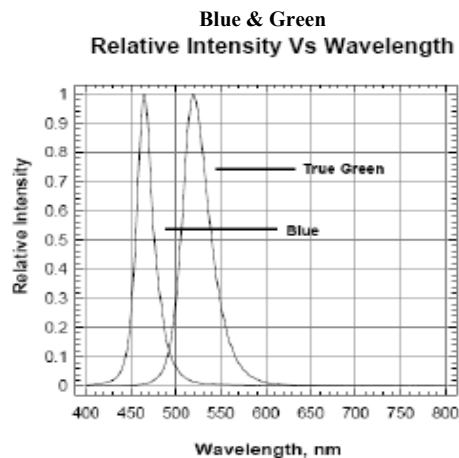
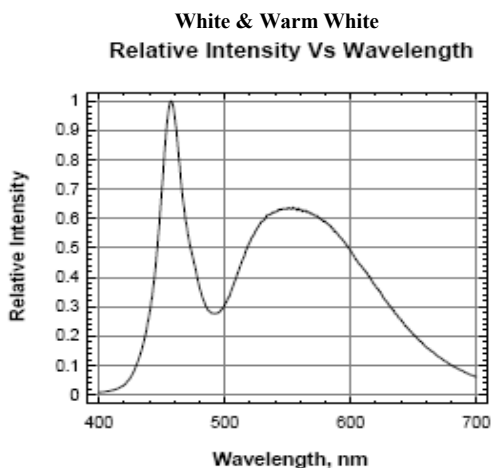
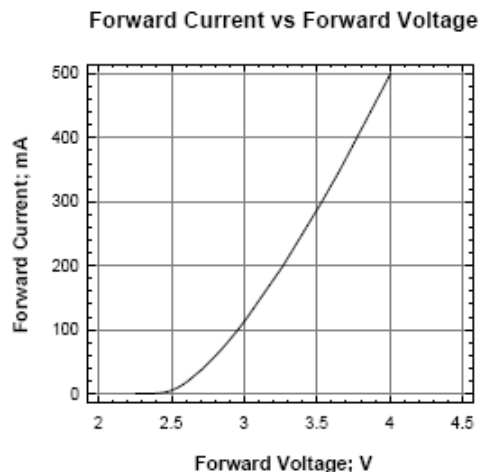
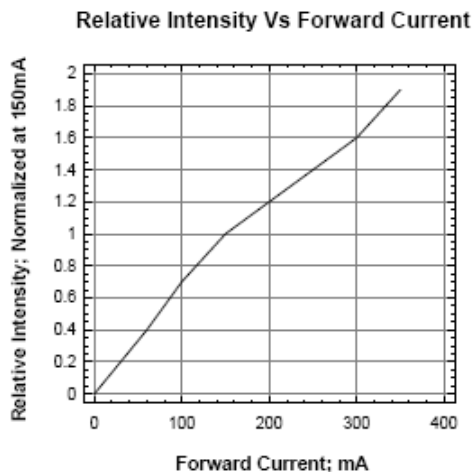

Beam Angle: All Col-

General Note

TT Electronics reserves the right to make changes in product specification without notice or liability. All information is subject to TT Electronics' own data and is considered accurate at time of going to print.

TT Electronics | OPTEK Technology
1645 Wallace Drive, Carrollton, TX 75006 | Ph: +1 972 323 2200
www.ttelectronics.com | www.optekinc.com

Mini Half-Watt SMD 3.5mm (120° Viewing Angle)



OVS5MxBCR4 Series

Solder Pad Design

Note: Metal core circuit board (MCPCB) is highly recommended for high density applications. FR-4 board is recommended for other applications

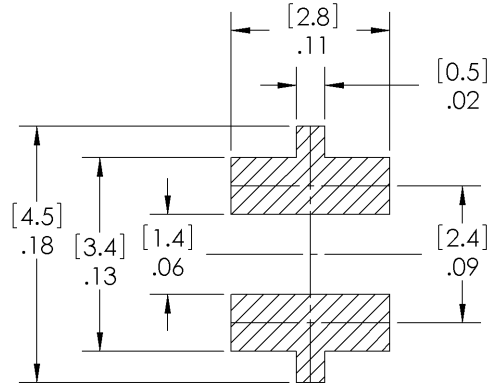

Solder Paste Pattern

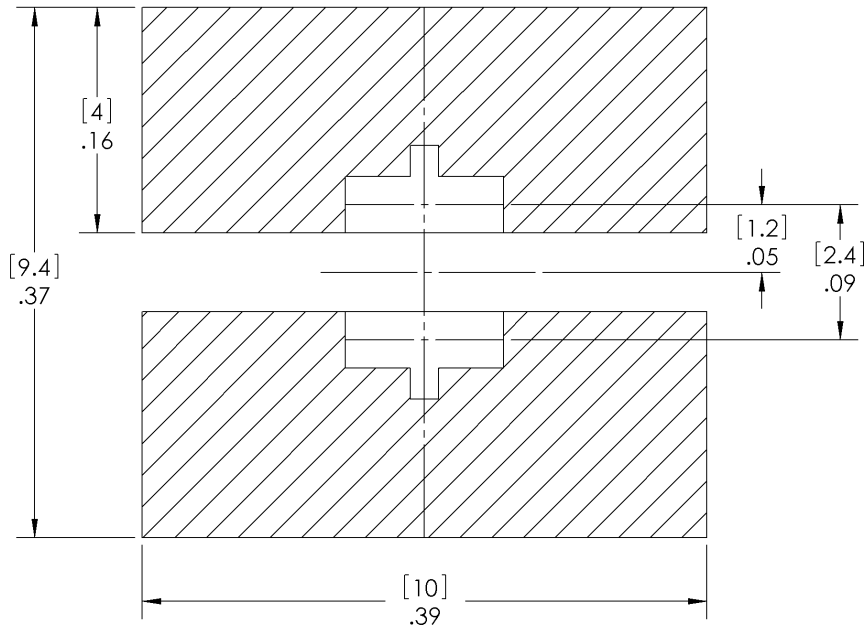

Copper Pattern

General Note

TT Electronics reserves the right to make changes in product specification without notice or liability. All information is subject to TT Electronics' own data and is considered accurate at time of going to print.

TT Electronics | OPTEK Technology
1645 Wallace Drive, Carrollton, TX 75006 | Ph: +1 972 323 2200
www.ttelectronics.com | www.optekinc.com

Mini Half-Watt SMD 3.5mm (120° Viewing Angle)



OVS5MxBCR4 Series

Recommended Sn-Pb IR-Reflow Soldering Profile.

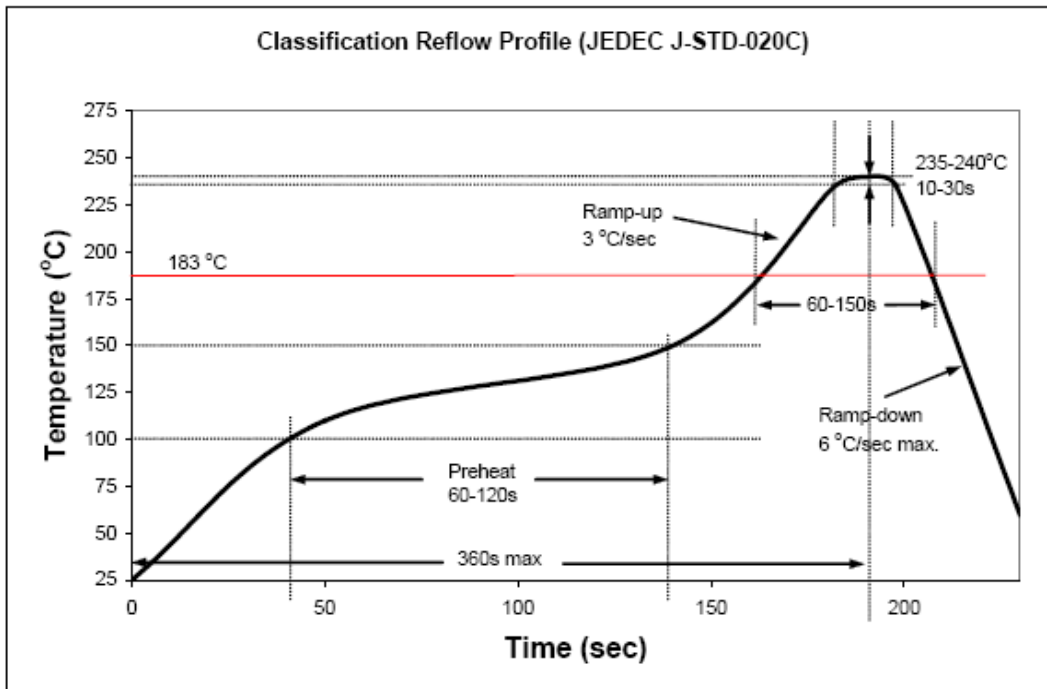

Recommended Pb Free IR-Reflow Soldering Profile.

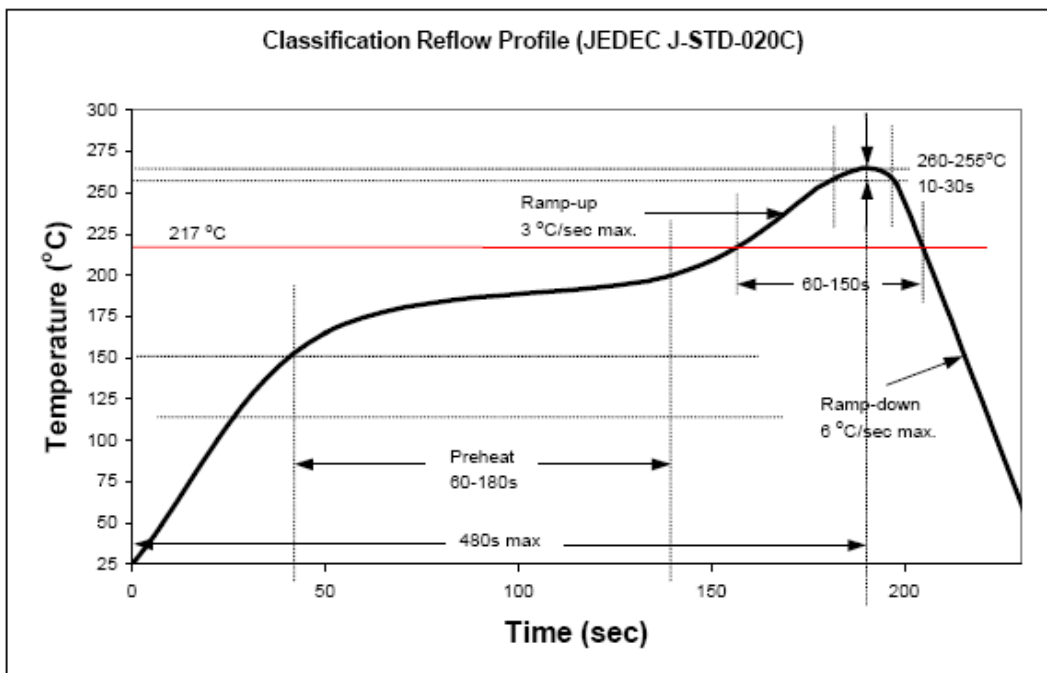

General Note

TT Electronics reserves the right to make changes in product specification without notice or liability. All information is subject to TT Electronics' own data and is considered accurate at time of going to print.

TT Electronics | OPTEK Technology
1645 Wallace Drive, Carrollton, TX 75006 | Ph: +1 972 323 2200
www.ttelectronics.com | www.optekinc.com

Mini Half-Watt SMD 3.5mm (120° Viewing Angle)



OVS5MxBCR4 Series

Reel Dimensions: 7-inch reel

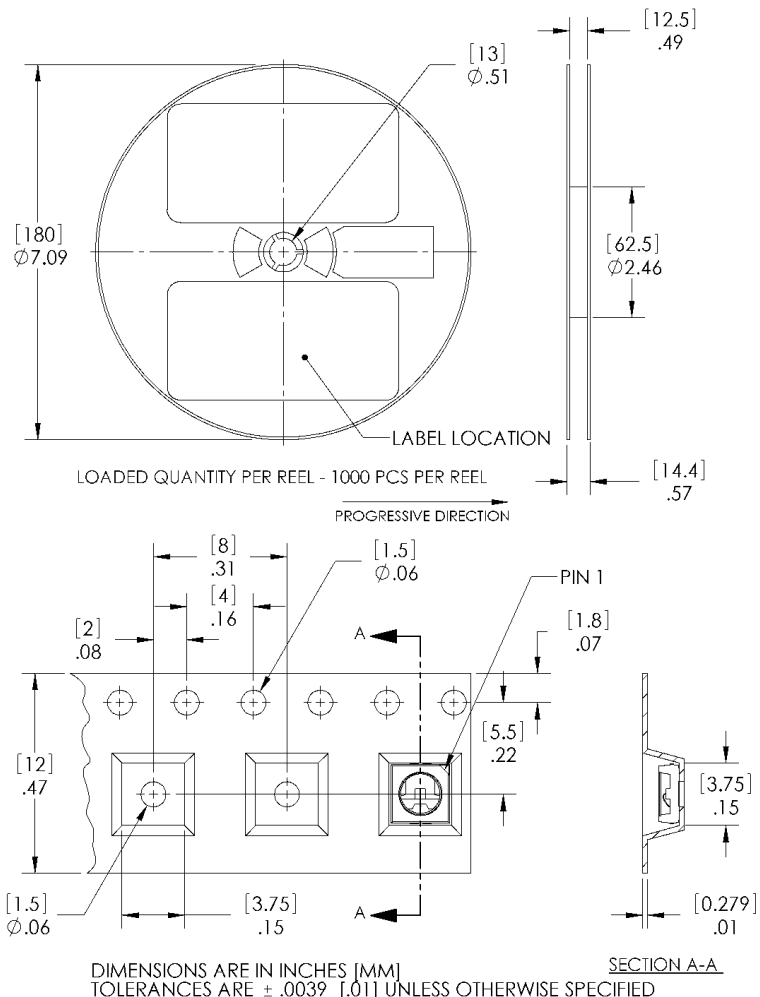

Carrier Tape Dimensions: Loaded quantity 1000 pieces per reel

Moisture Resistant Packaging

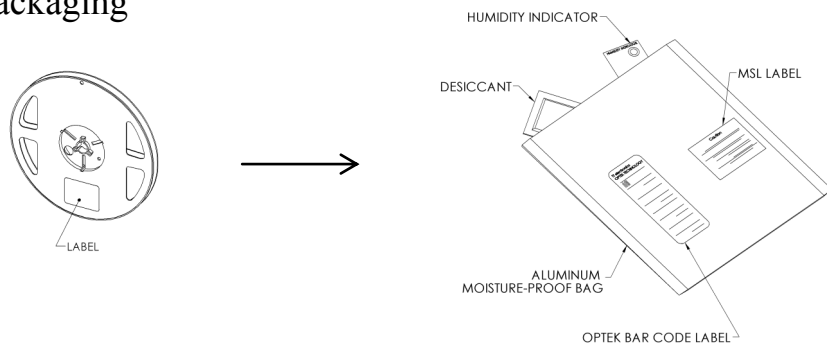

General Note

TT Electronics reserves the right to make changes in product specification without notice or liability. All information is subject to TT Electronics' own data and is considered accurate at time of going to print.

TT Electronics | OPTEK Technology
1645 Wallace Drive, Carrollton, TX 75006 | Ph: +1 972 323 2200
www.ttelectronics.com | www.optekinc.com

Mini Half-Watt SMD 3.5mm (120° Viewing Angle)



OVS5MxBCR4 Series

Issue	Change Description	Approval	Date
A	Initial Release—conforms to Dominant specifications: Primax - 0.5 watt (150mA) V1.0 (dated 11-21-08) Blue: 0.5 watt Red: 0.3 W Green: 0.5 watt Amber: 0.3 W White: 0.5 watt Yellow: 0.3 W Warm White: 0.5 watt Per Factory spec dated 5-27-09, the following changes were made: Page 1: Warm White Typ Luminous Flux (lm) changed from 18 to 25. Page 3: Combined the White & Warm White Luminous Flux Min & Max to read the same. Page 7: Replaced CCT graph with new one (removed the MA & MB range). Removed the MA & MB Cx/Cy data. Luminous Flux Table: removed M2 & M3. Added P2 & P3.	R. Bailey	06/10/09
A.1	Page 12: Removed the tape/reel configuration & 2k reel quantity. Replaced with new drawing & correct 1k reel quantity.	K. Bland	8/20/09
A.2	Page 2: ABSOLUTE MAX RATINGS—Peak Pulsed Forward Current. Removed “TBD” and added Red-Amber-Yellow @ 1000mA, Green-Blue-White-WarmWhite @ 350ma	K. Bland	10/12/09
B	Master Page: Change Issue A.2 dated 10/09 to Issue B dated 03/2011. Page 1: Updated all information tables. Page 2: Updated Absolute Maximum table with new data & added ESD & MSL ratings. Replaced all mechanical drawings & added Pin 1 & Pin 2 locations & Anode/Cathode information. Page 3: Updated all Optical Electrical Characteristics tables. Page 4 & 5: Removed Spectral Response graph. Replaced IV & Wavelength tables with new tables; all fitting on one page. Page 5: Added OVS5MWBCR4 (White) CCT bin structure with Black Body Curve, replaced Chromaticity Coordinate table with new one and updated Luminous Flux information. Page 6: Removed the OVS5MWBCR4 charts and replaced with OVS5MWWBCR4 (Warm White) CCT bin structure with Black Body Curve, replaced Chromaticity Coordinate table with new one. Luminous Flux remained the same. Page 7: Removed OVS5MWWBCR4 Warm White charts and tables. Replaced with Graphs for OVS5MABCR4, OVS5MRBCR4 & OVS5MYBCR4. Page 8: Removed graphs. Replaced with Graphs for OVS5MBBCR4, OVS5MGBCR4, OVS5MWBCR4 & OVS5MWWBCR4. Also moved the Beam Angle graph to this page. Page 9: Removed reliability data. Replaced with Solder & Copper Patterns. Page 10: Removed Radiation Pattern & Solder Pad Design. Replaced with SN-PB & PB IR reflow solder profiles. Page 11: Removed SN-PB & PB IR reflow solder profiles. Replaced with Reel / Tape and Moisture Packaging drawings. Page 12: Deleted.	K. Bland	3/31/11
C	Master Page: Changed from Issue B 04/2011 to Issue C 10/2011. OVS5MWWBCR4 Changes: Page 1: Typ Luminous Flux changed from 23 to 30. Page 3: Optical & Electrical Characteristics Table (Warm White) changed from Min 18.1 / Typ 23.5 / Max 30.6 TO: Min 23.5 / Typ 30 / Max 39.8. Page 6: Luminous Flux Table: Removed N2 & N3. Added Q2 & Q3.	K. Bland J. Plaster	10/26/11

General Note

TT Electronics reserves the right to make changes in product specification without notice or liability. All information is subject to TT Electronics' own data and is considered accurate at time of going to print.

TT Electronics | OPTEK Technology
1645 Wallace Drive, Carrollton, TX 75006 | Ph: +1 972 323 2200
www.ttelectronics.com | www.optekinc.com

Mini Half-Watt SMD 3.5mm (120° Viewing Angle)



OVS5MxBCR4 Series

Issue	Change Description	Approval	Date
D	<p>Master Page: Changed from Issue C 10/2011 to Issue D 02/2013.</p> <p>OVS5MBCR4: Page 1: Changed Typ Luminous Flux from 6 to 8.2 Page 3: Changed Luminous Flux FROM Min=4.9, Typ=6.0, Max=8.2 TO: Min=6.3, Typ=8.2, Max=10.7 Page 4: Removed IV codes H2 (4.9-5.5) & H3 (5.5-6.3). Added K2 (8.2-9.3) & K3 (9.3-10.7).</p> <p>OVS5MWBCR4: Page 1: Changed Typ Luminous Flux from 30 to 50. Page 3: Changed Luminous Flux FROM Min=23.5, Typ=30, Max=39.8 TO: Min=30.6, Typ=50, Max=67.2 Page 5: Removed IV codes P2 (23.5-26.8) & P3 (26.8-30.6). Added R2 (39.8-45.2), R3 (45.2-51.7), S2 (51.7-59.0) & S3 (59.0-67.2) .</p>	K. Bland / J. Plaster	2/8/2013

General Note

TT Electronics reserves the right to make changes in product specification without notice or liability. All information is subject to TT Electronics' own data and is considered accurate at time of going to print.

TT Electronics | OPTEK Technology
1645 Wallace Drive, Carrollton, TX 75006 | Ph: +1 972 323 2200
www.ttelectronics.com | www.optekinc.com