

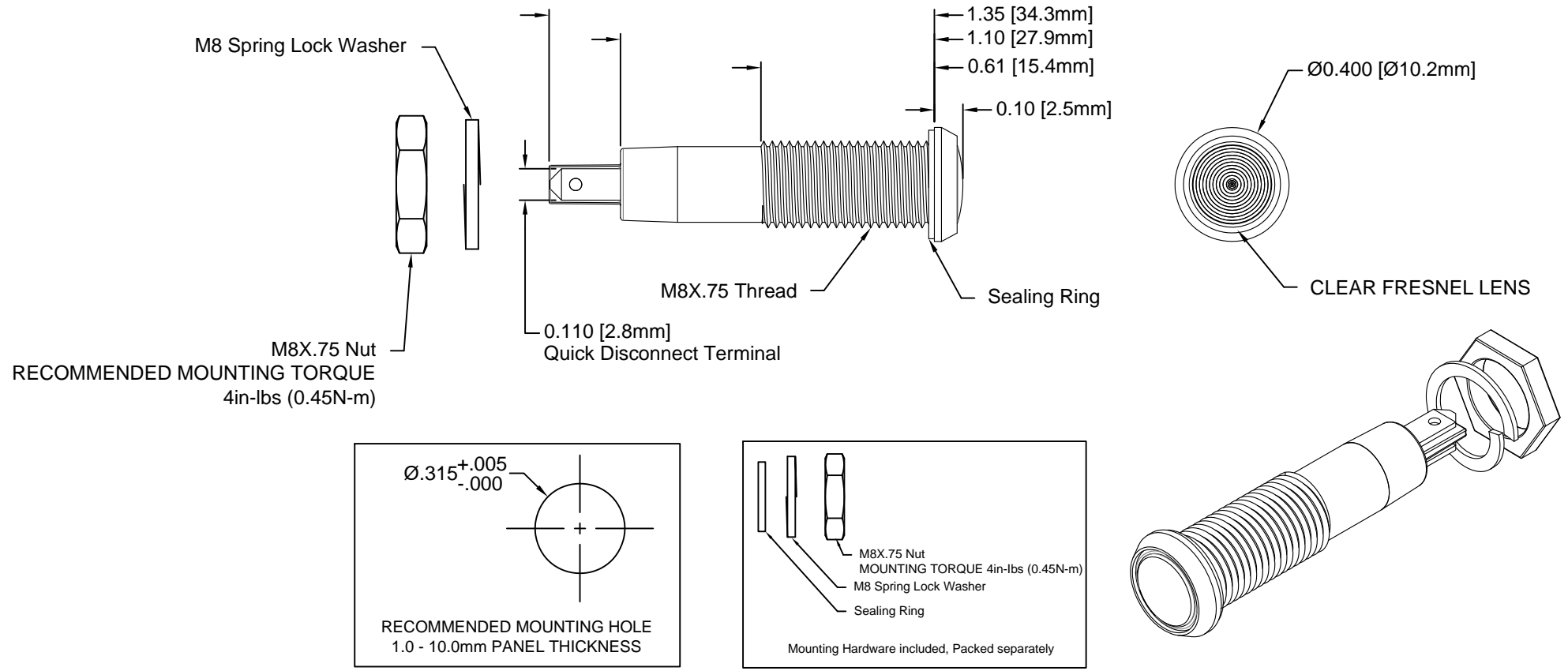

REV.	DESCRIPTION	DATE	APPROVED
H	Engineering Release	02/24/14	J. C.
J	Engineering Update w/o Changes	08/14/16	J. C.



NOTES:

1. SEALED TO IP67 RATING
2. WIDE RANGE VOLTAGE INPUT: 12 - 24VAC / DC (Ta = 25C)
3. BI-POLAR OPERATION
4. ROHS COMPLIANT
5. MOUNTING HARDWARE PACKED SEPARATELY NON-ASSEMBLED
6. INSERT RUBBER SEALING RING ON PANEL MOUNT ASSEMBLY PRIOR TO PANEL INSTALLATION
7. LIGHT OUTPUT ADJUSTS AUTOMATICALLY UPON AMBIENT LIGHTING CONDITIONS
8. VISIBLE ON AXIS FROM 0 ~ 150KLx INCIDENT LIGHT (DAYLIGHT, 6500K CCT)

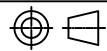
STANDARD TOLERANCE (UNLESS OTHERWISE SPECIFIED)		 4 THOMAS, IRVINE, CA. 92618 TEL: (949) 951-8808 FAX: (949) 951-3974	
DECIMALS	ANGULAR		
.X ± .1	X° ± 1°		TITLE: PM5-M124 SERIES PANEL MOUNT INDICATOR
.XX ± .02			PART NO: PM5-M124-XXX
.XXX ± .010		DESIGNED: B. Oliver	REVISION: J
		DATE: 07/25/13	CAGE CODE : 32559 SHEET # 1 OF 2
		CHECKED: T. Yin	CAD GENERATED DOCUMENT. DO NOT MEASURE DRAWING.
		DATE: 07/25/13	

REV.	DESCRIPTION	DATE	APPROVED
	SEE SHEET #1		

Part Number	Dominant Wave Length λ_d (nm)	Emitted Color	Lens Appearance	Voltage	TYP. LED Intensity Iv(mcd) @ 0Lx	Viewing Angle
PM5-M124-BLU	465	BLUE	WATER CLEAR	12-24 VAC/VDC	20	100
PM5-M124-GRN	530	GREEN	WATER CLEAR	12-24 VAC/VDC	20	100
PM5-M124-RED	625	RED	WATER CLEAR	12-24 VAC/VDC	20	100
PM5-M124-YLW	590	YELLOW	WATER CLEAR	12-24 VAC/VDC	20	100

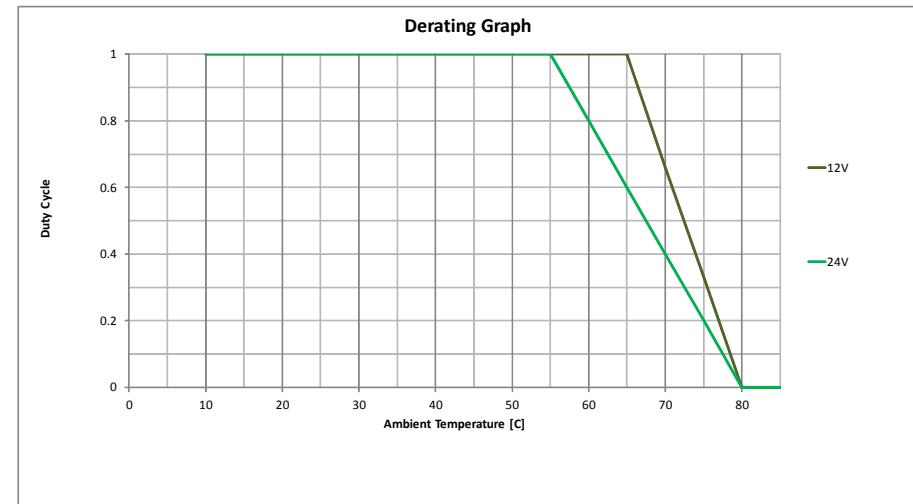
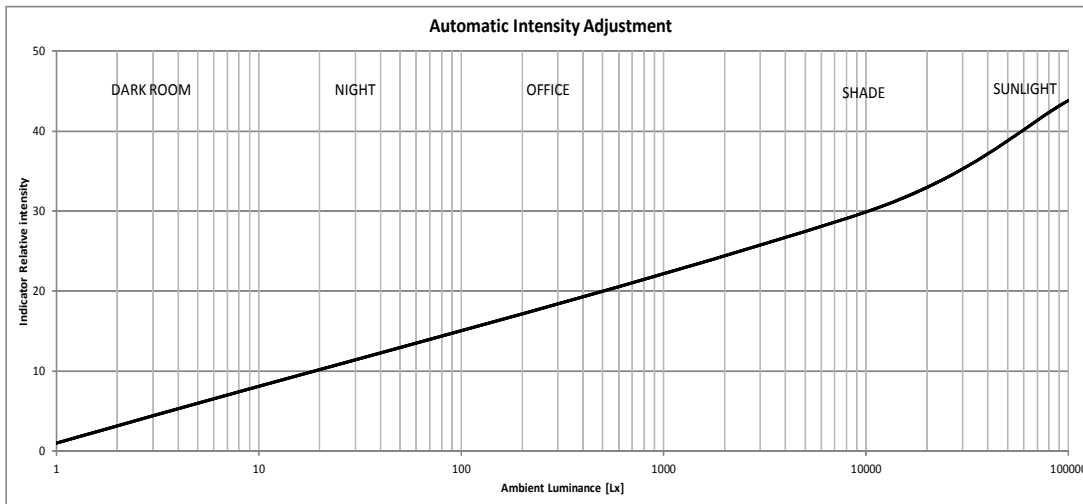

MAXIMUM PULSE DURATION _____ 1s
 MINIMUM RECOMMENDED PULSE DURATION _____ 0.02s

ABSOLUTE MAXIMUM RATINGS (Ta = 25°C)

INPUT VOLTAGE _____ 24VAC / VDC
 INPUT CURRENT _____ 20mA
 OPERATING TEMPERATURE RANGE _____ -40°C ~ 80°C
 STORAGE TEMPERATURE _____ -40°C ~ 80°C
 TERMINAL SOLDERING TEMPERATURE _____ 260°C, 5s

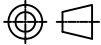
STANDARD TOLERANCE (UNLESS OTHERWISE SPECIFIED) DECIMALS ANGULAR		 4 THOMAS, IRVINE, CA. 92618 TEL: (949) 951-8808 FAX: (949) 951-3974	
			
DESIGNED: B. Oliver	DATE: 07/25/13	PART NO: PM5-M124-XXX REVISION: J	
CHECKED: T. Yin	DATE: 07/25/13	CAGE CODE : 32559 SHEET # 2 OF 2 CAD GENERATED DOCUMENT. DO NOT MEASURE DRAWING.	